

Addendum for L1000A Technical Manual

Table of Contents

1 GENERAL OVERVIEW	2
2 A3 INTERFACE	3
3 DI-A3 OPTION MULTI-FUNCTIONAL SUPPORT	10
4 ADVANCED LIGHT LOAD SEARCH	11
5 OUTPUT PHASE LOSS PROTECTION	12
6 DCP INTERFACE	13
7 CANOPEN-LIFT	65
8 RIPPLE COMPENSATION	75
9 PM PLAY	77
10 REPLACEMENT INSTRUCTIONS FOR SMART CONTROLLER DRIVES	78
11 APPENDIX	83

1 General Overview

◆ Scope

This documentation is valid for drives with the following model codes:

- CIMR-LC□F□□□□□□-913□
-

◆ About this Document

This manual is an addendum to the L1000A Technical Manual.

Always heed Safety Instructions as given in the Technical Manual when replacing a drive or performing installation and setup steps described here.

All conditions mentioned in the L1000A Technical Manual apply.

2 A3 Interface

◆ Overview

According to EN81-20:2014, new lifts must be equipped with a system independent of the drive control to prevent unintended car movement (UCM) away from the stop with open doors. This protection device has three functions:

- Recognition
- Tripping
- Braking

With gearless PM motors, the applied brake can be used as the “braking” part of the UCM-device. In this case, the brake function has to be monitored. With a certified brake response monitor function, the motor brake and the drive can act as parts of the UCM protective device.

■ Specification for Brake Response Monitor (BRM) Function

The brake monitor status function supports:

- Checking the status of the brakes at every run command
- Checking the correct switching of the brake within a defined time
- Locking the system if failure is detected

The Brake Response Monitor function is certified according to the normative requirements.

■ Checking the Status of the Brakes

The Brake Response Monitor (BRM) function checks the status of the brakes with every run command.

Setting 79h: “Brake Feedback” (N.O. signal)

Setting 5Bh: “Brake Feedback” (N.C. signal)

To comply with the EN81-20:2014 norm, the Brake Feedback function must be selected for two digital inputs simultaneously (e.g.: H1-07 = 79h & H1-08 = 79h).

Selecting the Brake Feedback function once or more than twice, or mixing the functions (selecting 79h & 5Bh) triggers an OPE03 fault if the Brake Response Monitor function is enabled (S6-17 = 1).

◆ Wiring

The motor is equipped with two brakes. In the figure below the brakes have two Normally Open (N.O.) switches, but Normally Closed (N.C.) operation is also possible.

When the motor brakes close, the switches close as well. This causes the digital inputs used for brake monitoring (e.g. S7 and S8) to change their logic state and unlock the drive allowing the run sequence to start.

The figure below shows how to wire the drive and motor brakes.

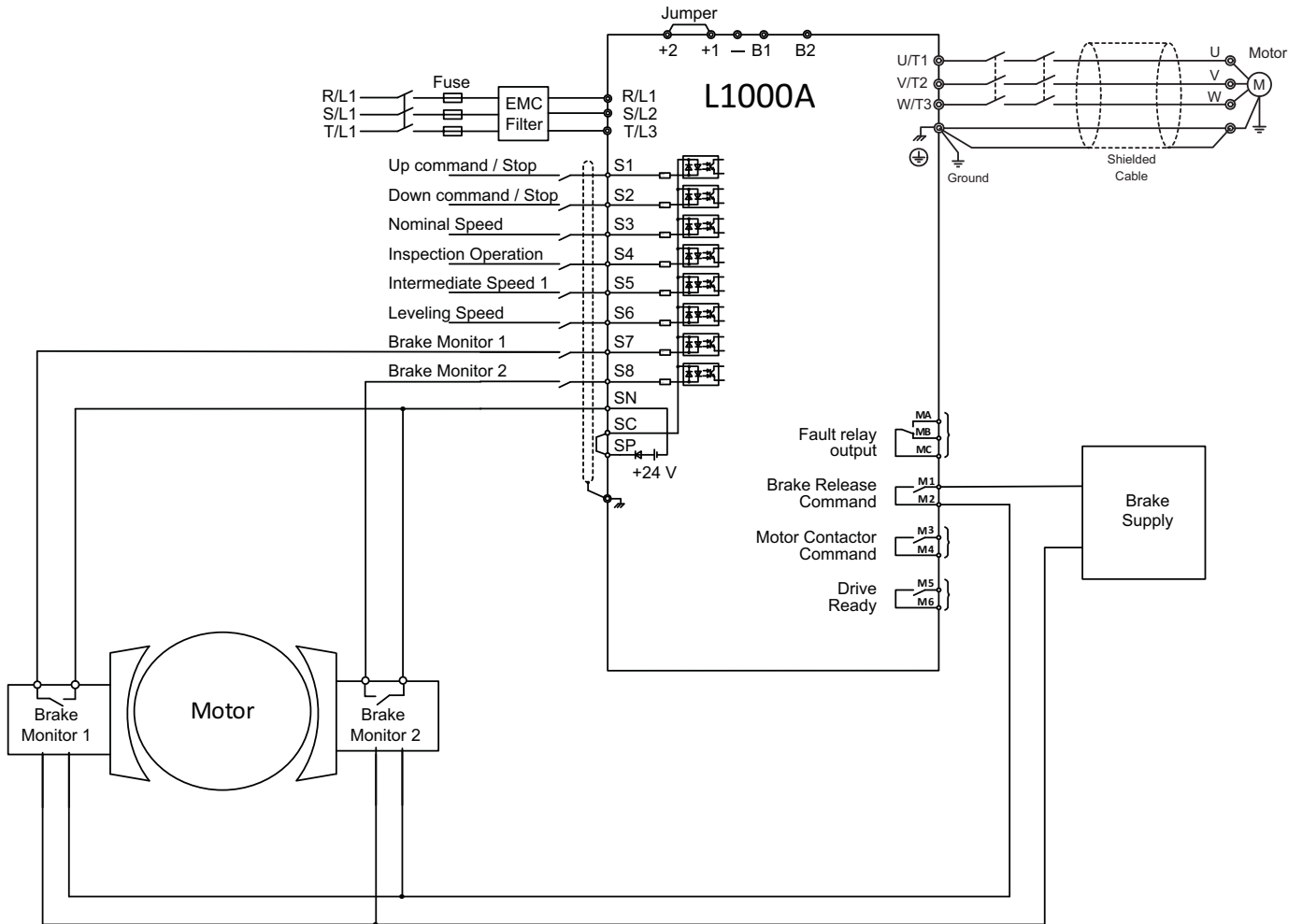

◆ Activation/Deactivation

The following table provides an overview of the parameters necessary for the Brake Response Monitor.

Parameter Number	Parameter Name	Setting Range
H1-□□	Brake Feedback 1	79h (N.O.)
	Brake Feedback 2	5Bh (N.C.)
S6-17	Brake Response Monitor	0 = Deactivated (Default) 1 = BRM Function Active
S6-05	Brake Response Error (SE4) Detection Time	Default 500 ms Min. 0 ms- Max. 60,000 ms
S6-06	Brake Response Error (SE4) Detection Time During Run	Default 500 ms Min. 0 ms - Max. 60,000 ms
S6-18	SE4 Fault Reset	0 = No reset (Default) 1 = Reset SE4 Fault

The Brake Response Error Time is adjustable in parameter S6-05. Default detection time is 500 ms. If S6-05 is set to 0 the SE4 fault detection during Start/Stop is disabled.

The Brake Response Error Time During Run is adjustable in parameter S6-06. Default detection time is 500 ms. If S6-06 is set to 0 the SE4 fault detection during Run is disabled.

■ Activation

The Brake Response Monitor (BRM) function is not active by default. The Brake Feedback function must be programmed to two digital inputs of the drive.

To activate the BRM function, perform the following steps:

- Set Parameter S6-17 = 1.
- Program the Brake Feedback function to two digital inputs of the drive.
For example:
 - Input S7 -> H1-07 = 79h
 - Input S8 -> H1-08 = 79h

If S6-17 = 0, but Brake Feedback 1 and Brake Feedback 2 are wired and Brake Control (H2-□□ = 50h) is used, the L1000A Brake Feedback Function is active, but the mode of operation is not A3-conform. This Brake Feedback function is just monitoring the brake operation and issues a fault if the brake's status does not match the brake command.

■ Deactivation

To deactivate the Brake Response Monitor (BRM) function, perform the following steps:

- Set Parameter S6-17 = 0.

The function is disabled.

◆ Fault Detection/Fault Reset

■ Fault Detection

If during the start or stop process Brake Feedback 1 and/or Brake Feedback 2 do not change their logic state within the time limit specified in S6-05 (Brake Response Error (SE4) Detection Time), an SE4 fault will be triggered and the drive will be locked.

If during Run Brake Feedback 1 or Brake Feedback 2 change their logic state for a time longer than S6-06 (Brake Response Error (SE4) Detection Time During Run), an SE4 fault will be triggered and the drive will be locked.

■ SE4 Fault Reset

With the Brake Response Monitor function enabled (S6-17 = 1), an SE4 fault cannot be reset by:

- Using the Reset button
- Power cycling the drive or installation
- Using the “Automatic Fault Reset” function (L5-□□)

The SE4 fault can be reset only by setting parameter S6-18 = 1.

With the Brake Response Monitor (BRM) function disabled (S6-17 = 0), an SE4 fault can be reset using the standard procedure.

■ Brake Feedback

Standard Behavior of Brake Feedback

After the Brake Release Command is set (brake open) during start procedure the drive starts a timer with the value set in parameter S6-05. If Brake Feedback function 79h is selected, both of the Brake Feedback Inputs must be set within the time set in S6-05. If Brake Feedback function 5Bh is selected, they must be reset within the time set in S6-05.

After the Brake Release Command is reset (brakes closed) during stop procedure the drive starts a timer with the value set in parameter S6-05. If Brake Feedback function 79h is selected, both of the Brake Feedback Inputs must be set within the time set in S6-05. If Brake Feedback function 5Bh is selected, they must be reset within the time set in S6-05.

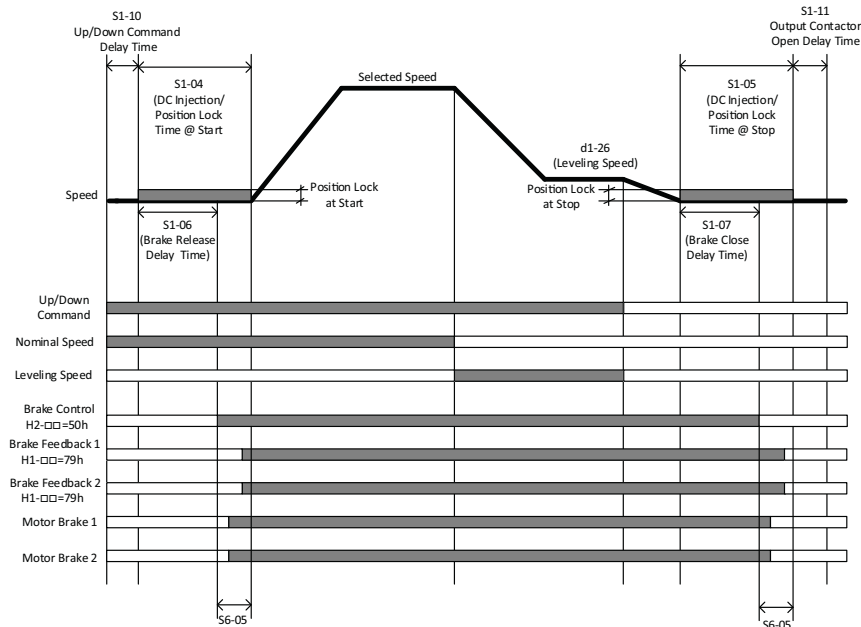

Figure 1 Normal Operation with MFDOs set to 79h (N.O.)

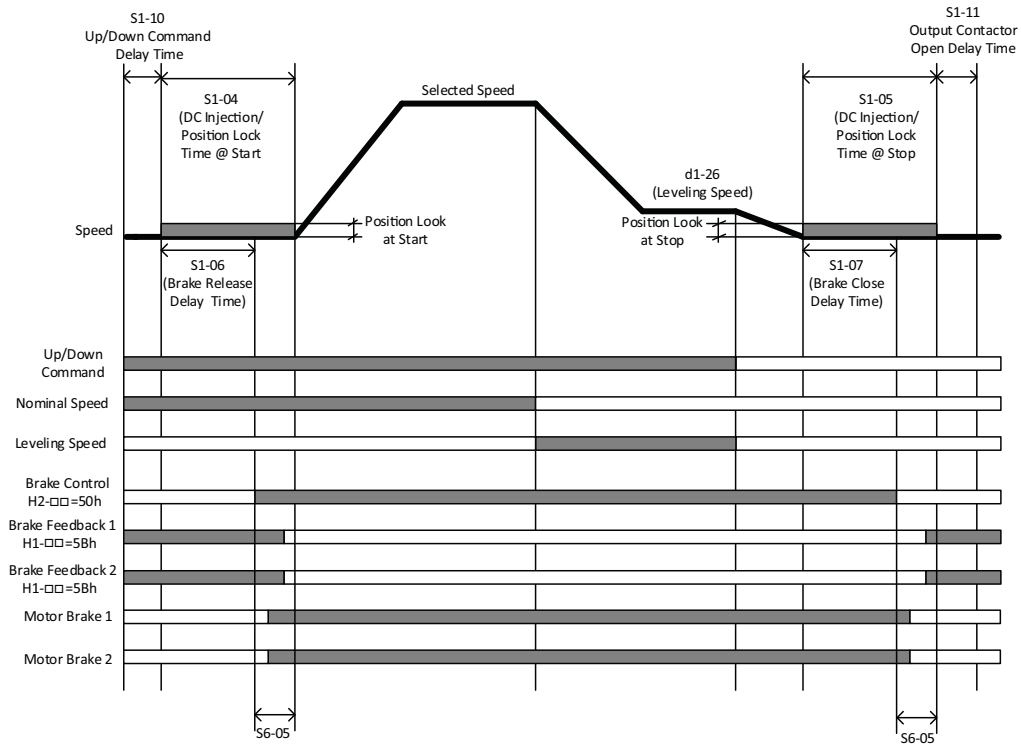

Figure 2 Normal Operation with MFDOs set to 5Bh (N.C.)

Fault during Start or Stop

If both Brake Feedback Inputs do not change their logic state within the time set in parameter S6-05, the drive stops the start/stop sequence and triggers an SE4 (Brake Response Error) fault.

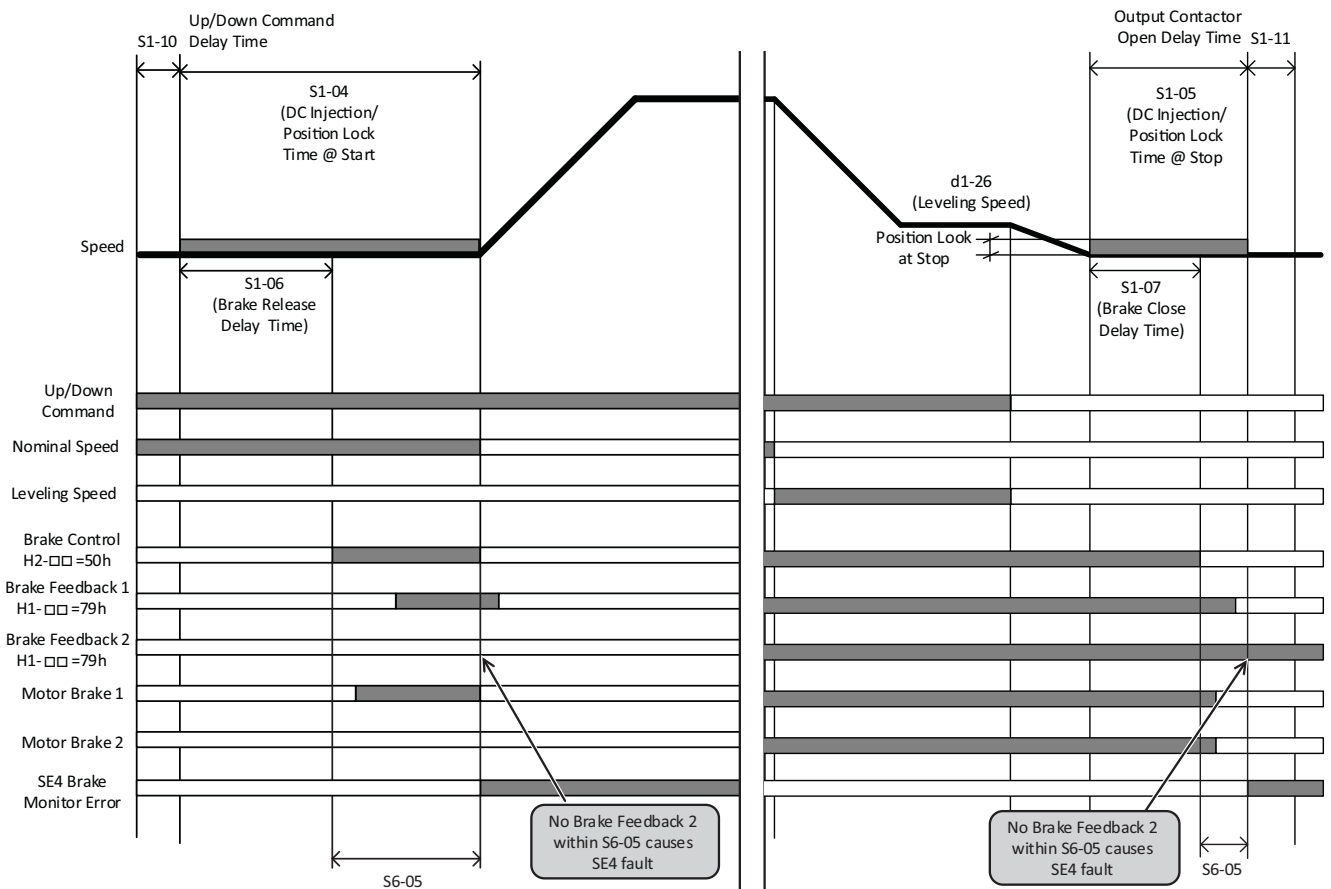

Figure 3 Fault during Start (left) and Fault during Stop (right)

Fault Behavior during Run

If at any point during Run the logic state of one of the Brake Feedback inputs changes unexpectedly, a countdown timer with the value of parameter S6-06 will be initiated. If the timer expires without change of Brake Feedback status to its expected state an SE4 Fault will be triggered and the fault message “Brake Response Error (SE4)” will be displayed.

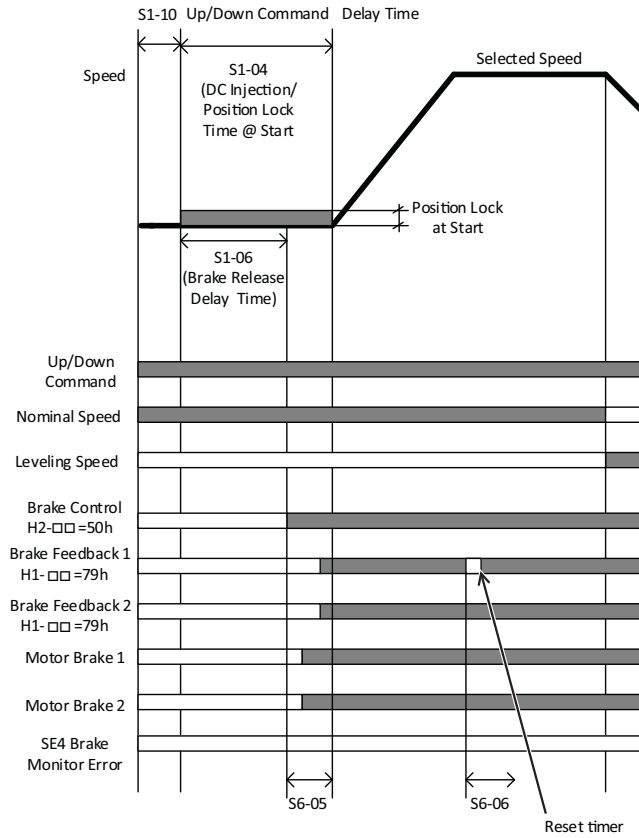

Figure 4 Short Disruption of Brake Feedback 1 Input during Run

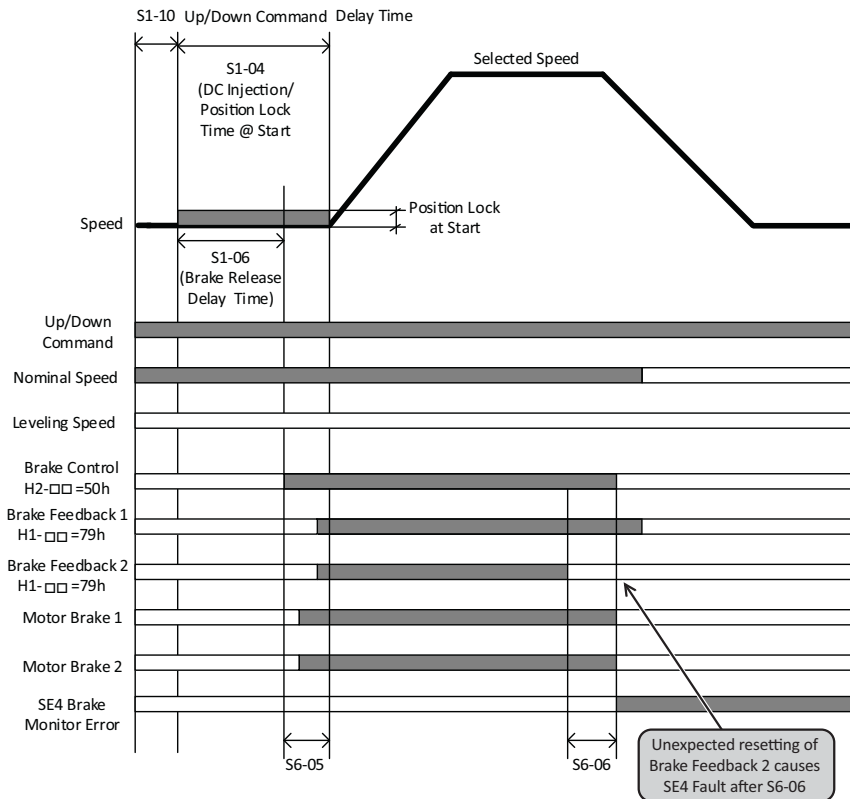

Figure 5 Fault during Run

◆ Function Test

Selecting the Brake Feedback function on only one or more than two digital inputs, or mixing the functions (selecting 79h & 5Bh) triggers an oPE03 fault if the Brake Response Monitor function is enabled (S6-17 = 1).

In case of an oPE03 fault, check if two inputs have been programmed as Brake Feedback and if they are both programmed to the same function.

For example:

H1-07 = 79h & H1-08 = 79h

or

H1-07 = 5Bh & H1-08 = 5Bh

If the Brake Response Monitor function is enabled (S6-17 = 1) and the SE4 fault appears, the Brake Monitor Function must be verified before the SE4 fault can be reset.

■ Function Test NPN Logic

The following steps have to be performed for the functional test after commissioning when using NPN logic:

1. Disconnect the signal Brake Feedback 1 (e.g. input S7).
2. Execute test travel.
3. During start an SE4 fault should be triggered and the drive should immediately stop.
4. The drive should be blocked and no further travel should be possible even after power cycle.
5. Reconnect the signal Brake Feedback 1.
6. Execute test travel.
7. The drive should be blocked and no further travel should be possible even after power cycle.
8. Unlock the drive by setting S6-18 to 1.
9. Execute test travel.
10. The drive should operate normally.

Repeat this NPN logic procedure for Brake Feedback 2 (e.g. input S8).

■ Function Test PNP Logic

The following steps have to be performed for the functional test after commissioning when using PNP logic:

1. Connect 24 V to Brake Feedback 1 (e.g. input S7).
2. Execute test travel.
3. During start an SE4 fault should be triggered and the drive should immediately stop.
4. The drive should be blocked and no further travel should be possible even after power cycle.
5. Disconnect 24 V on Brake Feedback 1.
6. Execute test travel.
7. The drive should be blocked and no further travel should be possible even after power cycle.
8. Unlock the drive by setting S6-18 to 1.
9. Execute test travel.
10. The drive should operate normally.

Repeat this PNP logic procedure for Brake Feedback 2 (e.g. input S8).

■ Brake Feedback

The following steps have to be performed to ensure correct operation of the Brake Feedback switches and function.

Brake Monitor 1

- Check if Motor Brake 1 operates correctly.
- Check status of Motor Switch in Brake 1.
- Check if the logic changes like specified.
- Check if Digital Input Brake Monitor 1 works correctly.
- Check in Monitor Parameter U1-10 if input change the status.

Brake Monitor 2

- Check if Motor Brake 2 operates correctly.
- Check status of Motor Switch in Brake 2.
- Check if the logic changes like specified.
- Check if Digital Input Brake Monitor 2 works correctly.
- Check in Monitor Parameter U1-10 if input change the status.

3 DI-A3 Option Multi-Functional Support

The DI-A3 option can be used to increase the number of digital inputs. To use this function, set parameter F3-01 = 8 [DI-A3 Option Input Selection = Multi-Functional]. All standard functions can be assigned to the option terminals D0 to D7 by using parameters F3-04 to F3-11 [Terminal D□ Function Selection]. If faults and alarms are set to terminals D0 to D7, the display messages „OEF0“ to „OEF7“ [DI-A3 Ext Faultx] will be shown. If no DI-A3 option card is installed, parameters F3-04 to F3-11 are not displayed.

Parameters F3-04 to F3-11 are displayed only when F3-01 = 8.

◆ Added and Modified Parameters for DI-A3 Multi-Functional Support

Parameter	MEMOBUS Address (Hex.)	Operator Display [Parameter Name]	Description	Range [Default]
F3-01	390	DI-A3 Opt InpSel [DI-A3 Option Input Selection]	Option Card Input Selection Selects the method to input the option card data. 0: BCD 1% unit 1: BCD 0.1% unit 2: BCD 0.01% unit 3: BCD 1 Hz unit 4: BCD 0.1 Hz unit 5: BCD 0.01 Hz unit 6: BCD custom setting (5 digit input), 0.02 Hz units 7: Binary input 8: Multi-Functional	0 - 8 [8]
F3-04	619	DI-A3 D0 FuncSel [Terminal D0 Function Selection]	Terminal function selection for DI-A3 option input. Same setting range as H1-03 to H1-08.	0 - 79 (Hex.) [0F (Hex.)]
F3-05	61A	DI-A3 D1 FuncSel [Terminal D1 Function Selection]		
F3-06	613	DI-A3 D2 FuncSel [Terminal D2 Function Selection]		
F3-07	614	DI-A3 D3 FuncSel [Terminal D3 Function Selection]		
F3-08	615	DI-A3 D4 FuncSel [Terminal D4 Function Selection]		
F3-09	616	DI-A3 D5 FuncSel [Terminal D5 Function Selection]		
F3-10	617	DI-A3 D6 FuncSel [Terminal D6 Function Selection]		
F3-11	618	DI-A3 D7 FuncSel [Terminal D7 Function Selection]		

◆ Added Faults and Alarms for DI-A3 Option

Fault	Alarm Code (Hex.)	Alarm Display [Alarm Name]	Description
OEF0 - OEF3	3C - 3F	DI-A3 Ext Fault0 - 3 [DI-A3 External Fault 0 - 3]	Digital Input Option DI-A3 External Fault An external fault has been triggered on an input terminal (D0 - D7) of the DI-A3 option.
OEF4 - OEF7	64 - 67	DI-A3 Ext Fault4 - 7 [DI-A3 External Fault 4 - 7]	

Alarm	Alarm Code (Hex.)	Alarm Display [Alarm Name]	Description
OEF0 - OEF3	2C - 2F	DI-A3 Ext Fault0 - 3 [DI-A3 External Fault 0 - 3]	Digital Input Option DI-A3 External Alarm An external alarm has been triggered on an input terminal (D0 - D7) of the DI-A3 option.
OEF4 - OEF7	49 - 4C	DI-A3 Ext Fault4 - 7 [DI-A3 External Fault 4 - 7]	

4 Advanced Light Load Search

The Advanced Light Load Search function (S4-01 = 3) detects the load condition during normal travel operation. Unlike search methods 1 and 2, this function does not move the car up and down when detecting the light load direction.

This function is also useful in applications where an excessive discharge of UPS during Light Load Search operation shall be avoided.

◆ Changed Parameters for Advanced Light Load Search

Available for all control methods.

Parameter	MEMOBUS Address (Hex.)	Operator Display [Parameter Name]	Description	Range [Default]
S4-01	6A6	LightLoad Search <i>[Light Load Direction Search Selection]</i>	0: Disabled 1: Enabled 2: Enabled for Motor 1 only 3: Advanced Search	0 - 3 [0]

Yaskawa recommends a full up/down travel with empty car for calibration.

To reset the calibration, set parameter S4-01 = 0.

5 Output Phase Loss Protection

Enables or disables the output phase loss detection which is triggered when the output current falls below 5% of the drive rated current.

◆ Changed Parameters for Output Phase Loss Protection

Available for all control modes.

Parameter	MEMOBUS Address (Hex.)	Operator Display [Parameter Name]	Description	Range [Default]
L8-07	4B3	OutPhLoss [Output Phase Loss Protection Selection]	0: Disabled 1: Triggered by a single phase loss 2: Triggered when two phases are lost 3: Fault at phase loss at start and during RUN	0 - 3 [0]

Setting 0: Disabled

Setting 1: Triggered by a single phase loss

An output phase loss fault (LF) is triggered when one output phase is lost. The output shuts off and the motor coasts to stop.

Setting 2: Triggered when two phases are lost

An output phase loss fault (LF) is triggered when two output phases are lost. The output shuts off and the motor coasts to stop.

Setting 3: Fault at phase loss at start and during RUN

An output phase loss fault (LF) is triggered when one or more phases are lost at motor start (before the brake opens) and when motor is moving. When LF has been detected, the motor coasts to stop.

When setting L8-07 = 3, set parameters S1-02 (only OLV and V/f) and S1-04 as follows.

- Set S1-02 (DC Injection Current at Start) to a value greater than 15%.
- Set S1-04 (DC Injection/Position Lock Time at Start) to a value greater than 100 ms.

An incorrect setting may result in poor performance or nuisance faults or alarms.

6 DCP Interface

The DCP is a point-to-point link between drive controller and lift controller. The two devices are linked via an RS-485 interface in semi-duplex mode.

For DCP serial communications, the terminal connections for RS485 R+/R-/S+/S- have to be used (R+ and S+ / R- and S- bridged).

◆ Network Cable Connection

- With the power shut off, connect the communications cable to the drive and the master. Use terminals R+/S+ and R-/S- for DCP.
- Set DIP switch S2 to ON position.

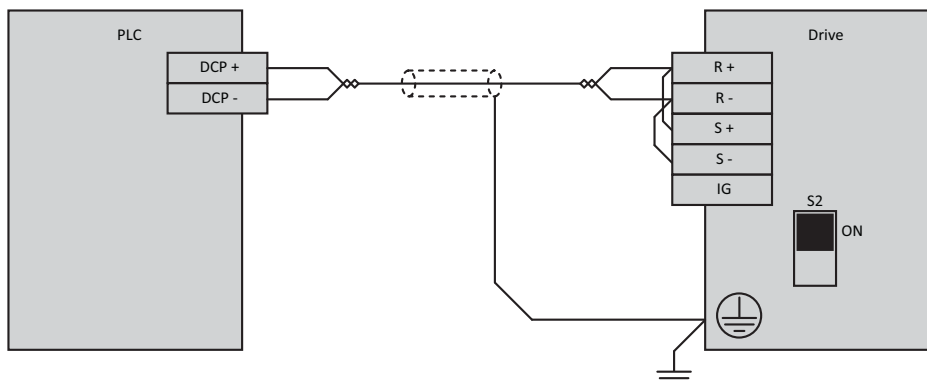

Figure 6 RS-485 DCP Connection

- Note:**
1. Turn on the DIP switch on the drive that is located at the end of the network. All other slave devices must have this DIP switch set to OFF position.
 2. Set H5-07 = 1 when using the RS-485 interface.
 3. Cycle power to apply the H5-07 change.

◆ Introduction

The DCP protocol distinguishes two modes:

DCP3 (for lift controllers without absolute encoder system in the shaft):

- Drive control via serial DCP link instead of digital inputs
- Status messages, such as fault and over-temperature, are transmitted via DCP link instead of by relay
- Monitoring of speed (such as releveling speed, deceleration speed, and overspeed)

DCP4 (for lift controllers with absolute encoder system in the shaft):

In addition to the DCP3 features:

- Time-optimized direct leveling dependent on remaining distance
- Millimeter-accurate adjustment, dependent on distance
- Supervision of deceleration at the shaft ends

◆ Characteristics of DCP Interface

In DCP mode a Master-Slave-architecture is used. The lift controller is the master device, the drive controller is the slave. Messages for communication between the devices are sent in a 15 ms cycle.

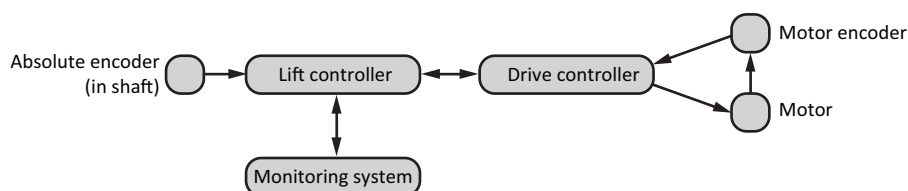

Figure 7 Typical DCP Topology

6 DCP Interface

Drive and lift controller are linked via RS-485 using the fixed settings:

- Baud rate: 38,400 Baud
- Parity: none
- Data bits: 8
- Stop bits: 1

■ Messages

- Time-critical, high speed process data (e.g. remaining distance, switch-off points, travel commands, etc)
- Non time-critical communication data (e.g. display control, transfer of keypad codes, etc.)
- Not more than 2 bytes of communication data are transferred with each message; the remaining bytes being used for fast process data.
- Each message is provided with a checksum byte

Master Messages from Lift Controller to Drive Controller:

Fixed length of 6 bytes

Process Data			Communication Data		Checksum
1	2	3	4	5	6
Command Byte	Data Byte 1	Data Byte 2	Communication Byte 1	Communication Byte 2	Checksum

Slave Messages from Drive Controller to Lift Controller:

Fixed length of 6 bytes

Process Data			Communication Data		Checksum
1	2	3	4	5	6
Status Byte	Data Byte 1	Data Byte 2	Communication Byte 1	Communication Byte 2	Checksum

◆ DCP Master Messages from Lift Controller to Drive Controller

■ Command Byte

Process Data			Communication Data		Checksum
1	2	3	4	5	6
Command Byte (B7 B0)	Data Byte 1	Data Byte 2	Communication Byte 1	Communication Byte 2	Checksum

The first byte of the message is called command byte. It contains the following information:

Bit B0: Drive controller enable

DCP3 and DCP4:

Information for the drive that there will be activation soon. This bit is set during a travel.

0: No activation of the drive (e.g. finish of travel or travel interruption)

1: Drive activation during travel

Bit B1: Travel command (DCP3); Change of actual distance (DCP4)

DCP3:

The speed is set with the travel command.

This bit is cleared at the deceleration point and the drive slows down to V0 (Crawl speed).

DCP4:

Remaining Distance Travel:

With a travel dependent on distance, bit B1 is cleared since the drive controller itself determines the optimum switch-off point.

The speed transferred before the start of the travel is just a limit.

Desired Distance Travel:

Not implemented.

Bit B2: Stop switch

DCP3:

The stop switch replaces terminal input V0 (Crawl speed)

DCP4:

In this mode, the lift controller signals that the drive controller is carrying out a travel dependent on distance

The stop switch is turned on from the start of the travel

When the drive controller reaches the remaining distance of 0 mm, the mechanical brake is applied. The lift controller then turns the stop switch off

Bit B3: Transfer of travel commands in the third byte of message

DCP3 and DCP4:

This bit tells the drive controller that the following 2 bytes (data bytes) are being used to transfer a speed

Bit B4: Direction of travel

DCP3 and DCP4:

This bit determines the direction of travel of the lift.

0: Upwards

1: Downwards

Bit B5: Speed change. B5 has the same functionality as B3 (internal OR-operation)

DCP3 and DCP4:

Same functionality as B3 (implemented as logical OR combination).

Bit B6: Desired distance / Actual distance (DCP4 only)

DCP4:

This bit chooses the type of transmitted distance

0: Actual Distance

1: Desired Distance (not implemented)

Bit B7: Error in last reply message

DCP3 and DCP4:

This bit is set if the lift controller has detected a checksum error in the last message from the drive controller and has therefore ignored it.

In this situation, the drive controller repeats the telegram automatically.

■ Data Bytes

Process Data			Communication Data		Checksum
1	2	3	4	5	6
Command Byte (B7 B0)	Data Byte 1	Data Byte 2	Communication Byte 1	Communication Byte 2	Checksum

The content of the two data bytes depends on the type of transmitted message.

Transmitted information:

- Speed Mode
- 15-bit remaining distance
- 16-bit remaining distance

■ Communication Bytes

Process Data			Communication Data		Checksum
1	2	3	4	5	6
Command Byte (B7 B0)	Data Byte 1	Data Byte 2	Communication Byte 1	Communication Byte 2	Checksum

The exact meaning and function of the communication bytes are described later.

■ Checksum Byte

Process Data			Communication Data		Checksum
1	2	3	4	5	6
Command Byte (B7 B0)	Data Byte 1	Data Byte 2	Communication Byte 1	Communication Byte 2	Checksum

The checksum is the result of an XOR operation across all 5 data bytes.

■ Definition of Messages

The following two tables show the valid messages of DCP3 and DCP4 Command mode and the meaning of the process information.

Nomenclature	
Setting	Meaning
0	bit is cleared
1	bit is set
□	any

Message Types in DCP3 Mode

Message Type	Command Mode Bits 7 6 5 4 3 2 1 0	Process Data		Communication Data		Checksum
	Byte 1	Byte 2	Byte 3	Byte 4	Byte 5	Byte 6
Idle Mode	□ 0 □ □ 0 0 0 0	any	any	0 - 255	0 - 255	0 - 255
Stop Mode	□ 0 □ □ 0 0 0 1	any	any	0 - 255	0 - 255	0 - 255
Re-leveling Mode	□ 0 □ □ 0 0 1 1	any	any	0 - 255	0 - 255	0 - 255
Deceleration Mode	□ 0 □ □ 0 1 0 1	any	any	0 - 255	0 - 255	0 - 255
Travel Mode	□ 0 □ □ 0 1 1 1	any	any	0 - 255	0 - 255	0 - 255
Speed Mode	□ 0 □ □ 1 0 0 1	Speed	Speed	0 - 255	0 - 255	0 - 255
Speed Mode after a Fast Start	□ 0 □ □ 1 1 1 1	Speed	Speed	0 - 255	0 - 255	0 - 255

Message Types in DCP4 Mode

Message Type	Command Mode Bits 7 6 5 4 3 2 1 0	Process Data		Communication Data		Checksum
	Byte 1	Byte 2	Byte 3	Byte 4	Byte 5	Byte 6
Idle Mode	□ 0 □ □ 0 0 0 0	any	any	0 - 255	0 - 255	0 - 255
Stop Mode	□ 0 □ □ 0 0 0 1	any	any	0 - 255	0 - 255	0 - 255
Re-leveling Mode	□ 0 □ □ 0 0 1 1	any	any	0 - 255	0 - 255	0 - 255
Remaining Distance Mode*	□ 0 □ □ 0 1 0 1	Remaining Distance MSB	Remaining Distance LSB	0 - 255	0 - 255	0 - 255
Deceleration Mode	□ 0 □ □ 0 1 0 1	any	any	0 - 255	0 - 255	0 - 255
Travel Mode	□ 0 □ □ 0 1 1 1	any	any	0 - 255	0 - 255	0 - 255
Speed Mode	□ 0 □ □ 1 0 0 1	Speed	Speed	0 - 255	0 - 255	0 - 255
Speed Mode after a Fast Start	□ 0 □ □ 1 1 1 1	Speed	Speed	0 - 255	0 - 255	0 - 255

* Note for message "□ 0 □ □ 0 1 0 1"

The next message after a Speed Mode message will decide how a "□ 0 □ □ 0 1 0 1" message is processed:

- If, after a Speed Mode change, a Travel Mode message follows, all occurrences of "□ 0 □ □ 0 1 0 1" messages are processed as Deceleration Mode messages.
- If, after a Speed Mode message, a "□ 0 □ □ 0 1 0 1" message follows, this and all other messages are processed as Remaining Distance Mode messages.

■ Speed Mode

DCP speeds correspond to parameters listed below. Speeds are transferred in bytes 2 and 3 (data bytes) once before a start of travel.

Speed Mode Bits	DCP Name of Speed Mode	L1000A Standard Speed Designation	Related L1000A Parameter	L1000A DCP Designation
G0	V0	Crawl	d1-26	V0 Speed
G1	VN	Re-leveling	d1-23	VN Speed
G2	VF	---	---	VF Speed
G3	V1	Intermediate 3	d1-04	V1 Speed
G4	VI	Inspection	d1-24	VI Speed
G5	V2	Intermediate 2	d1-03	V2 Speed
G6	V3	Intermediate 1	d1-02	V3 Speed
G7	V4	Fast	d1-01	V4 Speed
G8	V5	Intermediate 6	d1-07	V5 Speed
G9	V6	Intermediate 5	d1-06	V6 Speed
G10	V7	Intermediate 4	d1-05	V7 Speed

Speed modes V7, V6, V5, V2, and V1 are not available with DCP4.

◆ DCP Slave Messages from Drive Controller to Lift Controller

■ Status Byte

Process Data			Communication Data		Checksum
1	2	3	4	5	6
Status Byte (S7 ... S0)	Data Byte 1	Data Byte 2	Communication Byte 1	Communication Byte 2	Checksum

The first byte of the message is called status byte. It contains the following information:

Bit S0: Drive controller ready

DCP3 and DCP4:

The drive controller is ready for the next run. This status bit is similar to the terminal "Drive controller ready" at the lift controller.

0: Drive controller is not ready to travel

1: Drive controller is ready to travel

Bit S1: Travel active

DCP3 and DCP4:

The drive controller is currently carrying out a run.

0: Not in travel

1: In travel

Bit S2: Alarm active

DCP3 and DCP4:

The travel can be continued to the next floor. In this case, the lift controller should no longer give any travel commands while alarms are active.

Bit S3: Fault active

DCP3 and DCP4:

The drive controller error flag is set. The drive controlled has been switched off, the run contactor was closed, and the brake was applied. Possible causes of the fault include:

- Over-speed
- Over-current
- DC bus over-voltage
- DC bus under-voltage
- Motor parameter setting error
- Power section over-temperature

The command "Drive controller enable" (see command bit B0) must be cleared at this situation. The lift controller will not travel until the fault has been cleared on the drive side.

Bit S4: Motor speed below leveling speed ($v < 0.3$ m/s)

DCP3 and DCP4:

The motor speed has dropped to or below leveling speed. This signal is used for monitoring the re-leveling speed ($v < 0.3$ m/s) by the lift controller.

- 0: $v \geq 0.3$ m/s
- 1: $v < 0.3$ m/s

Bit S5: Desired distance / Speed accepted

DCP3 and DCP4:

- 0: During Emergency Stop or Stall Prevention
- 1: The speed was accepted by the drive controller

Bit S6: Mechanical brake

DCP3 and DCP4:

Corresponds to the mechanical brake relay of the drive controller.

- 0: Mechanical brake closed
- 1: Mechanical brake open

Bit S7: Error in last message received

DCP3 and DCP4:

This bit is set if the drive controller has detected a checksum error in the last message from the lift controller and has therefore ignored it.

In this situation, the lift controller repeats the telegram automatically.

■ Data Bytes

Process Data			Communication Data		Checksum
1	2	3	4	5	6
Command Byte (S7 S0)	Data Byte 1	Data Byte 2	Communication Byte 1	Communication Byte 2	Checksum

The content of the two data bytes depends on the type of transmitted message.

Transmitted information: Three different kinds of information can be transmitted:

- Extended status of the drive controller
- 15-bit deceleration distance
- 16-bit deceleration distance

• 1: Extended Status of the Drive Controller

Bit 0: V_{Unlock} Speed for Unlocking Zone

The actual speed is slower than the maximum speed for unlocking zone ($v < 0.8$ m/s).

- 0: The actual speed is faster or equal than the max. speed for unlocking zone ($v \geq 0.8$ m/s)
- 1: The actual speed is slower than the max. speed for unlocking zone ($v < 0.8$ m/s)

Bit 1: V_{Border} Border Speed

The actual speed is slower than the adjustable border speed (d1-30).

0: The actual speed is faster or equal than the border speed ($v \geq v_{\text{Border}}$)

1: The actual speed is slower than the border speed ($v < v_{\text{Border}}$)

Bit 2: V_{Over} Overspeed

The actual speed is slower than the adjustable overspeed (d1-31).

0: The actual speed is faster or equal than the overspeed ($v \geq v_{\text{Over}}$)

1: The actual speed is slower than the overspeed ($v < v_{\text{Over}}$)

Bit 3: Reserved

Currently not supported.

Bit 4 - 8: Reserved for Weight Detection

Currently not supported.

Bit 9: Emergency Power: Reduced DC Bus Voltage (Battery Supply/UPS)

The drive controller has reduced voltage (supplied by battery/UPS) during emergency power.

0: Reduced DC Bus voltage not active

1: Reduced DC bus voltage active

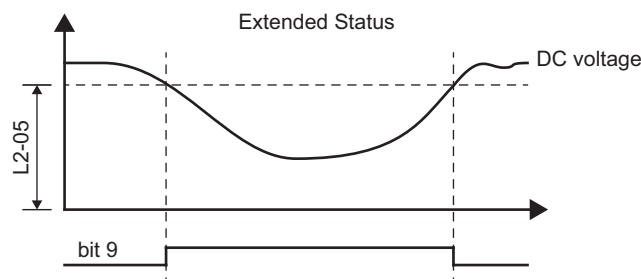
**Bit 10: Emergency Power: Recommended Travel Direction**

The drive controller recommends the travel direction during emergency power for the next travel.

0: Upwards (The counterweight is much heavier than the lift car)

1: Downwards (The lift car is much heavier than the counterweight)

Bit 11: Information: Temperature Limit "Motor"

If a certain threshold of the motor temperature is reached, the drive controller is signaling "temperature limit motor." The information can be used to avoid an overheating of the motor.

0: Actual motor temperature has not reached the temperature limit

1: Actual motor temperature has reached the temperature limit

- Note:**
1. The motor must be equipped with a PTC.
 2. The drive controller has to measure the motor temperature.

Appropriate countermeasures of the lift controller when reaching the temperature limit:

- The lift controller should increase the idle time in order to reduce duty cycle of the drive.
- In case of a lift group, another lift should get the preference for driving.

Unsuitable countermeasures of the lift controller when reaching the temperature limit:

- A reduction of the travel speed is unsuitable to counteract the overheating of the motor.

This functionality is configured by parameters L1-03 to L1-05 (PTC input).

Bit 12: Information: Temperature Limit "Drive"

The drive controller is signaling "temperature limit drive", if a certain threshold of the drive temperature is reached. The information can be used to avoid an overheating of the drive.

0: Actual drive temperature has not reached the temperature limit

1: Actual drive temperature has reached the temperature limit

6 DCP Interface

Appropriate countermeasures of the lift controller when reaching the temperature limit:

- The lift controller should increase the idle time in order to reduce duty cycle of the drive.
- In case of a lift group, another lift should get the preference for driving.
- If the drive permits, reducing the switching frequency.

Unsuitable countermeasures of the lift controller when reaching the temperature limit:

- A reduction of the travel speed is unsuitable to counteract the overheating.

The alarm level can be set with parameter L8-02 "Drive overheat pre-alarm (oH)."

Bit 13 - 14: Reserved

Currently not supported.

Bit 15: Mode Identification

The Extended Status information will only be available if the mode identification bit is set.

0: Braking Distance

1: Extended Status

• 2: 15-bit braking distance

The two data bytes are containing the actual 15-bit braking distance. The maximum braking distance is limited to 7FFF (Hex) (32767 mm).

While the lift car is stationary or just starting, the value for the braking distance is clamped at 7FFF (Hex). During acceleration, the value increases from 0. During constant speed, the braking distance remains constant.

Bit 15: Mode Identification

The braking distance will only be available if the mode identification is cleared.

Data Byte 1 (Bit 8 - 14): The MSB of the actual 15-bit Braking Distance

Data Byte 2 (Bit 0 - 7): The LSB of the actual 15-bit Braking Distance

• 3: 16-bit braking distance

The two data bytes are containing the actual 16-bit braking distance. The maximum braking distance is limited to FFFF (Hex) (65535 mm).

While the lift car is stationary or just starting, the value for the braking distance is clamped at FFFF (Hex). During acceleration, the value increases from 0. During constant speed, the braking distance remains constant.

Data Byte 1 (Bit 8 - 15): The MSB of the actual 16-bit Braking Distance

Data Byte 2 (Bit 0 - 7): The LSB of the actual 16-bit Braking Distance

Transmitted Information using Data Information Type '0'

The two data bytes are alternately filled by the braking distance (indicated to the lift controller by bit 15 being '0') and the Extended Status information (bit 15 being '1'). These values must be handled carefully because each type of transmitted information is updated every 30 ms only. For DCP3, the braking distance always reads 0.

Data Byte 1		Data Byte 2
Bit 15	Bit 8 - 14	Bit 0 - 7
0	15-bit braking distance	
1	Extended status	

Transmitted Information using Data Information Type '1'

This mode is not used in DCP3. In this mode, the two data bytes will be used only to transmit the actual 15-bit braking distance.

Data Byte 1		Data Byte 2
Bit 15	Bit 8 - 14	Bit 0 - 7
0	15-bit braking distance MSB	15-bit braking distance LSB

If bit 15 = 0, the value is evaluated as 15-bit braking distance.

Transmitted Information using Data Information Type '2'

In this mode, the two data bytes are used only for transmission of the Extended Status of the drive controller.

Data Byte 1		Data Byte 2
Bit 15	Bit 8 - 14	Bit 0 - 7
1	Extended Status	

If data shall be evaluated as Extended Status, bit 15 must be set to '1'.

Transmitted Information using Data Information Type '3'

This mode is not used in DCP3. In this mode, the data bytes are exclusively used to transmit the actual 16-bit braking distance.

Data Byte 1	Data Byte 2
Bit 8 - 15	Bit 0 - 7
16-bit deceleration distance MSB	16-bit deceleration distance LSB

Transmitted Information using Data Information Type '4'

In this mode, the data bytes are exclusively used to transmit the Extended Status of the drive controller.

Data Byte 1		Data Byte 2
Bit 15	Bit 8 - 14	Bit 0 - 7
1	Extended Status	

■ Communication Bytes

Process Data			Communication Data		Checksum
1	2	3	4	5	6
Status Byte (S7 S0)	Data Byte 1	Data Byte 2	Communication Byte 1	Communication Byte 2	Checksum

Refer to DCP Communication Data Channel on page 21.

■ Checksum Byte

Process Data			Communication Data		Checksum
1	2	3	4	5	6
Status Byte (S7 S0)	Data Byte 1	Data Byte 2	Communication Byte 1	Communication Byte 2	Checksum

The checksum is the result of an XOR operation across all 5 data bytes. The resulting value must be equal to the checksum, i.e. an XOR operation across all 6 bytes must yield 0.

◆ DCP Communication Data Channel

The communication data channel is embedded in the DCP frame and operated by its own protocol.

Process Data			Communication Data		Checksum
1	2	3	4	5	6
Status Byte (S7 S0)	Data Byte 1	Data Byte 2	Communication Byte 1	Communication Byte 2	Checksum

It allows:

- Access to all desired drive controller monitors and parameters
- Inverter remote control using keypad and display of the lift controller
- The exchange of additional data between lift controller and drive controller

■ Character Set

Data within the communication data channel is only transferred using ASCII characters.

- The transmitted characters are limited to the ASCII character set from 20 to FF (Hex).
- The remaining 32 characters are available for control purposes (0 to 1F (Hex)).

This offers advantages, especially for remote diagnostics, since an ASCII protocol can be easily integrated into a standardized data frame.

■ Data Transmission and Character Format

Since only ASCII characters from 20 to FF (Hex) are available for data transmission, it must be insured that no character outside this range occurs within the data stream as this would result in malfunctions.

An effective method of avoiding such problems is to convert the data bytes into ASCII format in order to ensure that they lie outside the range of control characters. This method offers the opportunity of an additional plausibility check to pick up transmission errors not detected by calculating the checksum (e.g. 2 bits falsified).

The transmitted data is encapsulated in the 6-byte DCP data frame.

STX Start Character User Data	...	ETX Stop Character
------------------------	-----	------------------	-----	-----------------------

■ Data Transmission Time-out Control

If messages are not exchanged within one second, the communication devices on both ends are automatically reset to their initial state.

If there is no "ETX" character received within one second after an "STX" character was received, the communication data channel is also reset to its initial state.

■ Control Modes

The communication channel can be operated in the following modes:

- Drive Remote Display Control via lift controller
- Drive Remote Keypad Control via lift controller
- Extended data communication between lift controller and drive controller
- Idle state

The whole ability to operate the drive controller is possible during remote operation. Display lines will be transmitted and shown when stopped as well as during travel. After changing a parameter at the drive controller via remote operation, the drive controller ready bit S0 must switch off and no further travel command needs to be accepted.

After leaving the remote operation without any modifications, the drive controller switches on the drive controller ready bit S0 and is ready to travel.

■ Breakdown of Control Character Range (0 to 1F (Hex))

Characters Common for Remote Keypad and Display Control

Communication Idle	00 (Hex)	Communication Idle
Message Identification	02 (Hex)	STX (Start of Text)
	03 (Hex)	ETX (End of Text)
Control Mode	1C (Hex)	Extended data communications
	1D (Hex)	Reserved
	1E (Hex)	Displaying and saving error messages from the drive controller in lift controller's event memory
	1F (Hex)	Remote control, used for both communication devices

Characters for Remote Display Control of Lift Controller

Line Number (depends on lift and drive controller)	04 (Hex)	Character output in line 1
	05 (Hex)	Character output in line 2
	06 (Hex)	Character output in line 3
	07 (Hex)	Character output in line 4
Cursor Position (depends on lift and drive controller)	08 to 1B (Hex)	Cursor position 0 to 19

Characters for Remote Keypad Control of Lift Controller

(Number of keys and the meaning of the keypad depend on drive controller)	00 (Hex)	No button pressed
	04 (Hex)	Button 1
	08 (Hex)	Button 2
	10 (Hex)	Button 3
	20 (Hex)	Button 4
	40 (Hex)	Button 5
	80 (Hex)	Button 6

Each button is assigned to one bit. This allows transferring information of simultaneously pressed buttons.

Example 1:

B&P lift controller "bp308" supports only 6 keys to remotely operate the drive controller. Key layout and assignment to the buttons:

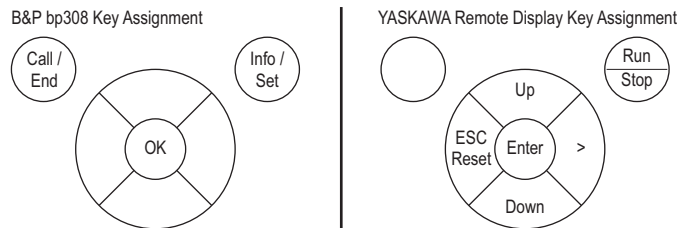

The button "ESC/Reset" functions like "ESC" in the programming menu, and like "Reset" in the fault display. The button "Run/Stop" issues a RUN command when not during RUN, and issues a STOP command when during RUN.

Example 2

Kollmorgen lift controller MPK400c supports only 5 keys to remotely operate the drive controller. Key layout and assignment to the buttons:

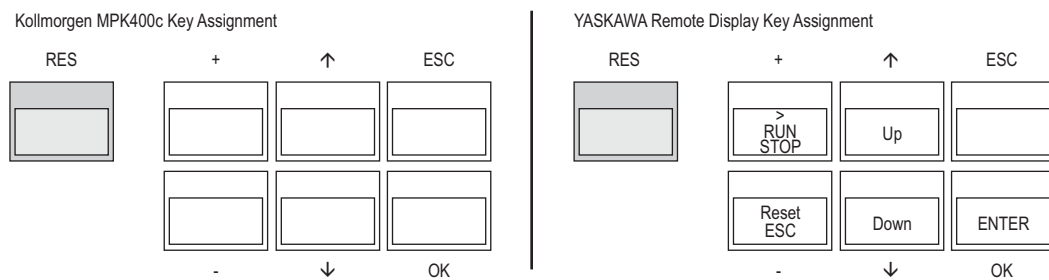

The button "ESC/Reset" functions like "ESC" in the programming menu, and like "Reset" in the fault display. The button "Run/Stop" issues a RUN command when not during RUN, and issues a STOP command when during RUN.

Example 3

Schneider Steuerungstechnik GmbH Lisa20 controller supports only 5 keys to remotely operate the drive controller. Key layout and assignment to the buttons:



The button "ESC/Reset" functions like "ESC" in the programming menu, and like "Reset" in the fault display. The button "Run/Stop" issues a RUN command when not during RUN, and issues a STOP command when during RUN.

Example 4

Strack Lift Automation SLC4-20 controller supports only 4 keys to remotely operate the drive controller. Key layout and assignment to the buttons:

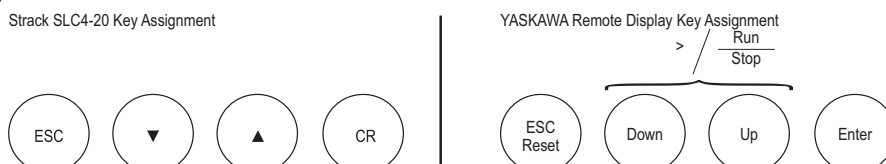

6 DCP Interface

The button "ESC/Reset" functions like "ESC" in the programming menu, and like "Reset" in the fault display. The button "Run/Stop" issues a RUN command when not during RUN, and issues a STOP command when during RUN. To use the functions ">" or "RUN/STOP" press the buttons "Down" and "Up" at the same time.

Characters for Extended Data Communication

1 st Character	49 (Hex)	'I' character - Internal command
2 nd Character	30 (Hex)	'0' character - Manufacturer identification
	31 (Hex)	'1' character - Determine data byte 2 and 3 content
	32 (Hex)	'2' character - Switching function
	37 (Hex)	'7' character - Travel distance parameter
	39 (Hex)	'9' character - Actual position

■ Drive Controller Remote Display Control (1F (Hex))

In this mode, the display of the lift controller is used for outputting the drive controller's menu texts. Switching to this mode is initiated with the character string (STX) (1F (hex)) and ends with an (ETX) character. The lift controller recognizes a display control character (line, cursor position) immediately and outputs the subsequently transmitted characters at the required position.

The drive controller starts transferring remote display information as soon as a remote key command has been received from the lift controller. When no remote key has been pressed for more than 30 seconds, the drive controller stops sending remote display information.

Example 1: Displaying a complete display line

STX	1F	Line	Cursor Position	Character 1	...	Character n	ETX
-----	----	------	-----------------	-------------	-----	-------------	-----

Example 2: Displaying several characters at different positions

STX	1F	Line	Cursor Position	Character 1	Line	Cursor Position	Character 2	...	ETX
-----	----	------	-----------------	-------------	------	-----------------	-------------	-----	-----

If another (STX) character is sent before an output data stream ended, the complete display has to be cleared (e.g. in case of sporadic interruption of communication), and the transmission is restarted.

■ Drive Controller Remote Keypad Control (1F (Hex))

In this mode, the keypad of the lift controller is used to pass user input to the drive controller. Switching to this mode is initiated with the character string (STX) (1F (hex)) and ends with an (ETX) character.

A keystroke transfer has the following format:

STX	1F (Hex)	Button	ETX
-----	----------	--------	-----

■ Idle State

If data is not being communicated on the channel, null bytes are transferred (0 (Hex)), i.e. communication is idling.

0 (Hex)

■ Synchronization / Communication Device Reset

The communication device can be reset to its initial state (display cleared) at any time with the character string (STX) (ETX) (generally recommended before switching control mode 1C, 1E, 1F (Hex)).

STX	ETX
-----	-----

In the initial state, all Tx and Rx communication buffers of the drive are cleared. The drive is ready to receive any new valid message from the lift controller.

■ Saving Device Controller Error Messages (1E (Hex))

It is possible for the drive controller to intervene asynchronously in an exchange of messages at any time in order to display drive controller error messages on the lift controller display and to save it to the lift controller's event log.

If a message transmission is already in progress, the drive controller should first complete this message before sending the error message. Following this procedure prevents a loss of data. Switching to this mode is initiated with the character string (STX) (1E (Hex)) and ends with an (ETX) character.

An error message output has the following format:

STX	1E (Hex)	Character 1	Character 2	...	Character n	ETX
-----	----------	-------------	-------------	-----	-------------	-----

n = 1 to 20

The Error message for Yaskawa inverter drives is specified as follows:

Only the LCD Message Fault Display is transferred, e.g. " EF3 " for External Fault 3, not the fault Message text " Ext Fault S3 ". The same fault is only transferred once and not repeated.

■ Extended Data Communication between Lift and Drive Controller (1C (Hex))

In this mode, additional data can be exchanged between lift controller and drive controller. Switching to this mode is initiated with the character string (STX) (1C (Hex)) and ends with an (ETX) character.

Extended Data Transmission in Communication Channel (1C (Hex))

The messages defined by the date of publication of this document are described below. The lift controller always initiates communication. Only the drive controller responds.

Initialization Message ('I' '0')

The lift controller and the drive controller start communication with the following initialization messages. After that, both of the controllers check and adjust their settings.

The drive controller receives the language settings from the lift controller and switches to the same language. When the drive controller is not able to support the received language setting, it needs to switch to English language (same as default setting).

When the drive controller has received no or only a faulty initialization message ('I','0') from the lift controller, it must not activate any travel sequence. When a travel start sequence is initiated nevertheless, the inverter triggers a fault (DCE2) and forces a time-out of 1 second (Tx and Rx channels are cleared, Rx messages are ignored for 1 second), and the lift controller must send a new initialization message.

Initialization Message from Lift Controller

The lift controller sends inquiry after switching on / reset and disconnection (timeout).

STX	1Ch	'I'	'0'	HK1	HK2	V1x.xx	Vx1.xx	Vxx.1x	Vxx.x1	D	D	M	M	Y	Y	LK1	LK2	ETX
Lift controller manufacturer's identification				Version number (tens, ones, tenths and hundredths place)				Date of software				Country identifier (ISO 639) in capital letters (DE for Germany)						

Response Initialization Message from Drive Controller

The drive controller responds with the following message after receiving the lift controller's message.

STX	1Ch	'I'	'0'	HK1	HK2	V1x.xx	Vx1.xx	Vxx.1x	Vxx.x1	D	D	M	M	Y	Y	DCP	LK1	LK2	ETX
Drive controller manufacturer's identification (YE for Yaskawa)				Version number (tens, ones, tenths and hundredths place)				Date of DCP implementation				Type of DCP ('0' = DCP Com Channel, '3' = DCP3, '4' = DCP4); selected by parameter H5-13				Country identifier (ISO 639) in capital letters (JA for Japan)			

Manufacturer Codes

Lift Controller Manufacturer		Drive Controller Manufacturer	
Name	ID	Name	ID
Böhnke + Partner GmbH	BP	ABB Asea Brown Boveri Ltd	AB
Kollmorgen Steuerungstechnik GmbH	KN	Brunner & Fecher Regelungstechnik GmbH	BF

Lift Controller Manufacturer		Drive Controller Manufacturer	
Name	ID	Name	ID
NEW LIFT Steuerungsbau GmbH	NL	Bucher Hydraulics AG	BH
OSMA Aufzüge, Albert Schenk GmbH & Co KG	OS	Control Techniques GmbH	CT
Schneider Steuerungstechnik GmbH	LI	Danfoss GmbH	DA
Strack Lift Automation GmbH	ST	Emotron Lift Center GmbH	DE
		Fuji Electric GmbH	FE
		Gefran Deutschland GmbH	SS
		MagneTek (UK) Ltd.	MT
		RST Elektronik GmbH	RS
		Thyssen Krupp Aufzugswerke GmbH	TY
		Venzke-DriveCon GmbH	VZ
		Yaskawa Europe GmbH	YE
		Ziehl-Abegg AG	ZA

Setting Up the Data-Information-Type ('I' '1')

By transmitting this message during the initialization phase, the following items are determined:

- Whether the lift controller transmits the remaining distance in 15-bit or 16-bit mode
- Whether the drive controller transmits the braking distance in 15-bit or 16-bit mode or not at all
- Whether the drive controller transmits the Extended Status
- Whether the drive controller alternately transmits the Extended Status and the 15 bit braking distance (for DCP3, 0x00 is transferred for the braking distance)
- Whether the drive's response message to the message ('I','9') is transmitted with or without additional information

Data-Information-Type Message from Lift Controller

The lift controller sets up the kind of information in the data bytes while transmitting this message during initialization.

STX	1C	'I'	'1'	Protocol Type	Data Information Type	ETX
-----	----	-----	-----	---------------	-----------------------	-----

- Protocol Type "Extended Data Communication":

'0' Base Protocol ('I','9' response message without additional information)

'1' Extended Protocol ('I','9' response message with additional information)

- Data Information Type:

Sets up of the type of information transmitted in data bytes 1 and 2:

Lift Controller Data Bytes	Drive Controller Data Bytes
'0' Remaining distance using 15 bit mode	Braking distance using 15-bit mode and Extended Status of the drive controller are transmitted alternately
'1' Remaining distance using 15 bit mode	Braking Distance using 15 bit mode
'2' Remaining distance using 15 bit mode	Extended Status of the drive controller
'3' Remaining distance using 16 bit mode	Braking Distance using 16 bit mode
'4' Remaining distance using 16 bit mode	Extended Status of the drive controller

If no ('I' '1') message is transmitted by the lift controller, the data-information-type will be set to '0' on both controllers.

Response Data-Information-Type Message from Drive Controller

If the drive controller receives a base protocol request or does not support the extended protocol, it responds with the message:

STX	1Ch	'I'	'1'	ETX
-----	-----	-----	-----	-----

If the drive controller receives the extended protocol request and does support the extended protocol, it responds with the message:

STX	1Ch	'I'	'1'	'1'	ETX
-----	-----	-----	-----	-----	-----

Switching Function ('I' '2')

This message is used to realize advanced functions.

Switching Function Message from Lift Controller

To activate the designated function, the data byte 'switching function' is used.

STX	ICh	'1'	'2'	Reserve	Switching Function	ETX
-----	-----	-----	-----	---------	--------------------	-----

Switching Function:

'0' No function selected or function reset

'1' Activate function "Maximum Torque". The next (but only the next) travel is executed with maximum drive torque

'R' Function 'Inverter Fault Reset' is executed

- Function "Maximum torque":

After activating the function "Maximum Torque", the torque limitation in the drive is set to the maximum possible level during the next travel.

After the next stop, the drive switches back to the previous torque limit. The lift controller can judge the movements of the traction sheave using telegram 'I,9'. This allows a monitoring of rope slip or traction ability.

Response to Switching Function Message from Drive Controller

If the message type is supported by the drive, it responds with the message:

STX	ICh	'1'	'2'	Reserve	Switching Function	ETX
-----	-----	-----	-----	---------	--------------------	-----

Switching Function

'0' no function in accordance to the message ('1' '2') is active

'1' the function "Maximum Torque" is active

'R' Command 'Inverter Fault Reset' is executed

The torque limits for all quadrants (L7-01 to L7-04) are temporarily opened to 300%. After the next stop, the drive switches back to the previously set torque limitation (parameter settings).

Date/Time ('1' '3')

The lift controller can transmit the current time and date to the drive controller. This can be used by drive controllers without a real-time clock to synchronize their calculated clock. This information is not used in L1000A.

Date/Time Message from Lift Controller

The lift controller transmits the message after each initialization message ('1' '0') plus once per day (preferred at "day changeover").

STX	ICh	'1'	'3'	D	D	M	M	Y	Y	Y	Y	H	H	M	M	S	S	ETX
				Day (01 - 31)		Month (01 - 12)		Year (2000 - 9999)				Hour (00 - 23)		Minute (00 - 59)		Second (00 - 59)		

If the lift controller doesn't support this message type, no Date/Time-message will be received by the drive controller. In this case, the drive controller has to operate without a synchronization of the clock.

Response to Date/Time Message by Drive Controller

As confirmation, the drive controller sends the following message to the lift controller.

STX	ICh	'1'	'3'	ETX
-----	-----	-----	-----	-----

"Emergency Power Supply"/"Energy Saving Mode" Message ('1' '6')

After switching on the emergency supply, the drive controller is sending information to the drive controller. With this information, the drive controller is able to execute the travel with reduced energy consumption. The Energy Saving Mode is enabled only in case of CLV/PM control mode.

"Emergency Power Supply"/"Energy Saving Mode" Message from Lift Controller

After switching on the emergency supply, the drive controller is sending the following message.

STX	ICh	'1'	'6'	Power Supply	Energy Saving Mode	ETX
-----	-----	-----	-----	--------------	--------------------	-----

6 DCP Interface

Power Supply

'N' Normal mains operation

'U' Emergency supply

The 'U' request is taken by the drive controller to reduce the regular undervoltage level (L2-05) of the drive. In this condition, the UV level is at 50 V for 400 V units, and at 25 V for 200 V units.

Energy Saving Mode

'0' No energy saving mode - normal operation

'1' Energy saving mode 1 (In CLV/PM inverter control mode only)

'2' Energy saving mode 2 (In CLV/PM inverter control mode only)

When no message ('I' '6') is sent, normal mains operation without energy-saving mode is set up.

Response to "Emergency Power Supply"/"Energy Saving Mode" Message by Drive Controller

The drive controller responds with the same telegram in case it supports these modes. If a mode is not supported, it responds with the actual mode it works.

STX	ICh	'I'	'6'	Power Supply	Energy Saving Mode	ETX
-----	-----	-----	-----	--------------	--------------------	-----

Power Supply

'N' Normal mains operation

'U' Emergency supply (The drive immediately indicates that it is operating below normal undervoltage levels (L2-05) by transferring 'U')

Energy Saving Mode

'0' No energy saving mode - normal operation

'1' Energy saving mode 1 (In CLV/PM inverter control mode only)

'2' Energy saving mode 2 (In CLV/PM inverter control mode only)

If the telegram is not supported and the drive does not respond, the controller assumes normal main supply without energy-saving mode.

When energy-saving modes '1' or '2' are switched ON, parameter b8-01 is set to 1 when in CLV/PM control mode. When '0' is transferred, b8-01 is set back to 0.

Start Parameter Message ('I' '7')

Before starting a travel, the lift controller transmits the desired travel distance and the allowed maximum lift speed to the drive controller. After calculation of the optimal speed, the drive controller answers with the minimum distance to travel and the required deceleration distance according to the calculated speed.

Start Parameter Message from Lift Controller

Before each travel, the lift controller sends the following message:

STX	ICh	'I'	'7'	V_{max}	Ss1	Ss2	Ss3	Ss4	Ss5	ETX
-----	-----	-----	-----	-----------	-----	-----	-----	-----	-----	-----

V_{max} (Maximum lift speed):

'1' = Intermediate Speed 1 (V3 in DCP notation)

'2' = Fast Speed (V4 in DCP notation)

Ss1 ... Ss5

Desired distance in cm (ASCII coded decimal format)

(Ss1: 10⁴-digit; Ss2: 10³-digit; Ss3: 10²-digit; Ss4: 10¹-digit; Ss5: 10⁰-digit)

Response to Start Parameter Message by Drive Controller

The drive controller responds with the following message.

STX	lCh	'l'	'7'	f _{typ}	Sg1	Sg2	Sg3	Sg4	Sg5	Sv1	Sv2	Sv3	Sv4	Sv5	ETX
-----	-----	-----	-----	------------------	-----	-----	-----	-----	-----	-----	-----	-----	-----	-----	-----

f_{typ}

Type of travel ('s' = short travel, 'l' = long travel, with l (long), the maximum lift speed is reached; with s (short) it's not reached).

Sg1 ... Sg5

Total distance in cm (ASCII coded decimal format). If S_s > S_g, a long travel (l) is performed.

(Sg1: 10⁴-digit; Sg2: 10³-digit; Sg3: 10²-digit; Sg4: 10¹-digit; Sg5: 10⁰-digit)

Sv1 ... Sv5

Deceleration distance in cm (ASCII coded decimal format). The remaining distance can be extended if it is longer than Sv.

(Sv1: 10⁴-digit; Sv2: 10³-digit; Sv3: 10²-digit; Sv4: 10¹-digit; Sv5: 10⁰-digit)

Weight Measurement State of the Car ('l' '8')

To improve the drive's starting behavior, optionally, the lift controller can send the percentage value of the car load weight before starting a travel.

Weight Measurement Message from Lift Controller

Before starting the travel, the lift controller optionally sends the load weight as a percentage of the nominal load.

STX	lCh	'l'	'8'	L1	L2	L3	ETX
-----	-----	-----	-----	----	----	----	-----

L1 ... L3

ASCII coded percentage value of the load weight relating to the nominal load in BCD-format. L1: hundreds, L2: tens, L3: ones

Examples:

0: Car empty, load 0%

25: Load 25%

100: Full load 100%

The function should not be used in conjunction with the Fast-Start function.

Response Weight Measurement Message from Drive Controller

The drive controller responds with the following message.

STX	lCh	'l'	'8'	ETX
-----	-----	-----	-----	-----

Compatibility to Former Lift- and Drive-Controller Software

To achieve compatibility to former lift- and drive-controller software:

- The drive controller must also accept the starting command of the lift controller without getting the "l8" message before.
- The lift controller has to send the starting command also in case of not receiving the drive controller's response of the "l8" message.

Position Message ('l' '9')

The actual position of the lift car is sent from the lift controller to the drive controller after each stop. It is the distance in mm between the actual position and the lowest floor level. That also applies to travels using the speed assignments VI (inspection), V0 (crawl) or VN (re-leveling).

If the extended protocol mode was activated by the message 'l','1' before, the drive controller transmits the travel distance in its response message. This information can be used by the lift controller to calculate the slip.

6 DCP Interface

Position Message from Lift Controller

After each stop, while the drive is stationary, the lift controller sends the position.

STX	1Ch	'I'	'9'	SIGN	P1	P2	P3	P4	P5	P6	ETX
-----	-----	-----	-----	------	----	----	----	----	----	----	-----

SIGN (Sign / Result)

('E': invalid value, '+': positive value, '-': negative value)

P1...P6

Position (value in mm from lowest floor level)

Response to Position Message by Drive Controller

The drive controller's response message is dependent on the activated protocol type.

- Base Protocol

If the base protocol is activated or the drive controller supports only the base protocol, the drive responds with the message:

STX	1Ch	'I'	'9'	ETX
-----	-----	-----	-----	-----

- Extended Protocol

If the extended protocol is activated and supported by the drive controller, the drive controller responds with a message containing the distance of its last travel measurement including sign.

STX	1Ch	'I'	'9'	SIGN	D1	D2	D3	D4	D5	D6	ETX
-----	-----	-----	-----	------	----	----	----	----	----	----	-----

SIGN (Sign / Result)

('E': invalid value, '+': positive value, '-': negative value)

D1...D6

Distance of the last travel in mm with sign calculated from motor encoder.

◆ DCP Behavior in Event of Transmission Errors

■ Lift Controller

A) The lift controller has detected a checksum error in the drive controller's reply message.

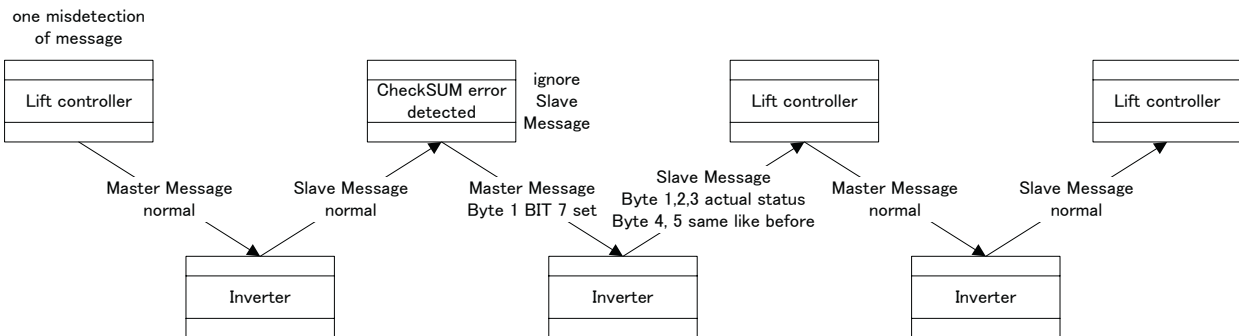

B) Bit 7 (error in last message received) is set in the status byte of the reply message.

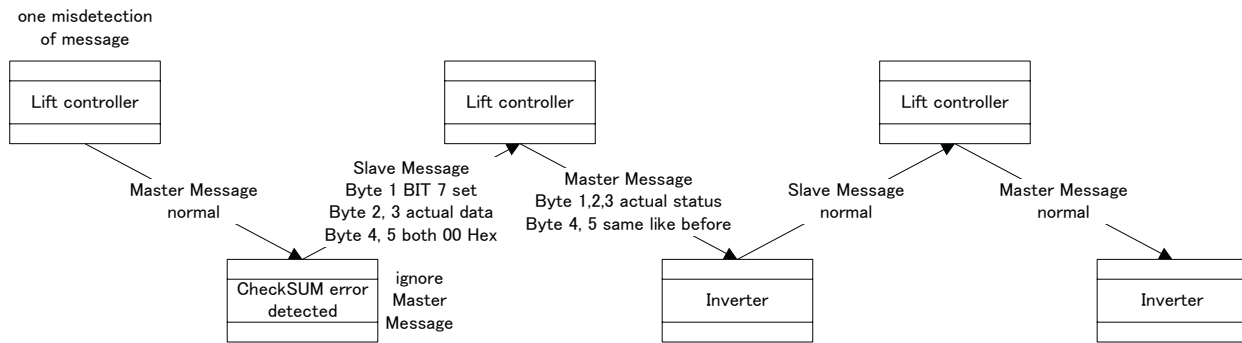

Bit 7 of byte 1 in master and slave message can initiate a resending of the previous message. In both cases, it is necessary to respond as follows:

The type of message must be maintained (i.e. bytes 4 and 5 are the same as in the previous message). The actual values are transferred as commands.

■ Drive Controller

A) The drive controller has detected a checksum error in the message received from the lift controller. The drive controller ignores the message and sends a reply message with the following content:

Status Byte: Contains the actual status of the drive controller with bit 7 set (error in the last message received)

Process Data: Contains the actual extended status or the actual deceleration distance (which is 0x00 in DCP3 mode)

B) In the message from the lift controller to the drive controller, bit 7 (error in last reply message) is set in the command byte. The current commands are processed normally. The drive controller repeats the last message sent.

Note:

If one of both devices is detecting a checksum error in a message when also bit 7 (error in last message) is set, this bit must be ignored by the receiving device. In DCP4 mode, the drive controller's use of remaining distance message simplifies the behavior:

- The lift controller always sends the current command byte and the remaining distance
- The drive controller always replies with the current status byte
- In the event of transmission errors, only the last communication byte sent is repeated

◆ Basic DCP Serial Communication Parameters

■ Interface

RS485 is used as physical layer. Transmission from the lift controller to the drive controller is serial and asynchronous.

Baud rate: 38.400 Baud

Data bits: 8

Parity: none

Stop bits: 1

■ Timing

Since a half-duplex interface is used, the corresponding line drivers must be switched on or off dependent on the transmission direction. To avoid collisions, the following timing has to be followed:

Maximum Tx transmission driver switch-off time: 0.5 ms after the last bit was sent

Maximum time delay for responding to a lift controller message: 10 ms after the last bit was received

Lift controller message transmission start: 0 ms

Latest time for switching off lift controller's Tx driver / Earliest time for drive controller transmission start: 2.0624 ms

Latest drive controller transmission start: 11.5625 ms

Latest time for switching off drive controller Tx driver / Earliest start for sending next lift controller message: 13.625 ms

This leads to a transfer cycle of: 15 ms

6 DCP Interface

The lift controller must ensure that the distance is transmitted at least 30 ms before the corresponding deceleration point is reached. In other words, the reply message from the drive controller, which tells the lift controller whether the new desired distance is accepted, must have arrived at the lift controller before the deceleration point is reached, even if the message exchange has to be repeated due to a transmission error.

■ Time-out Safety Function

During a travel, if 10 successive messages are received incorrectly or were lost completely (corresponds to 150 ms without communication), the drive controller triggers a fault (DCE1). The stopping method is executed according to b1-03 setting.

While the drive controller is stopped, if further 10 successive messages are received correctly, the operation resumes automatically.

There is no error message when the DCP link is interrupted while the drive is stationary.

Note: To further improve safety, it is recommended that the lift controller also checks if the messages are received correctly. In case of errors, it should act accordingly.

◆ DCP Travel Sequence Definitions

This chapter explains the nomenclature used for the diagrams in the following chapters.

■ Nomenclature

In the following chapters, the DCP speed notation is used. The following abbreviations are used for the remaining distances and travel types:

SV5, SV6, SV7, SV1, SV2, SV3, and SV4	Fixed deceleration distance for DCP3 travels using speeds V5, V6, V7, V1, V2, V3, and V4
SV3' and SV4'	Maximum slowing down distance for DCP4 travel limited to V3 and V4
V3' travel, V4' travel, and VN' travel	Travel dependent on remaining distance and limited to speed V3, V4, and VN

SV3 (distance for DCP3), SV3' (distance for DCP4)

■ Diagrams

The diagrams used in this specification have the following form:

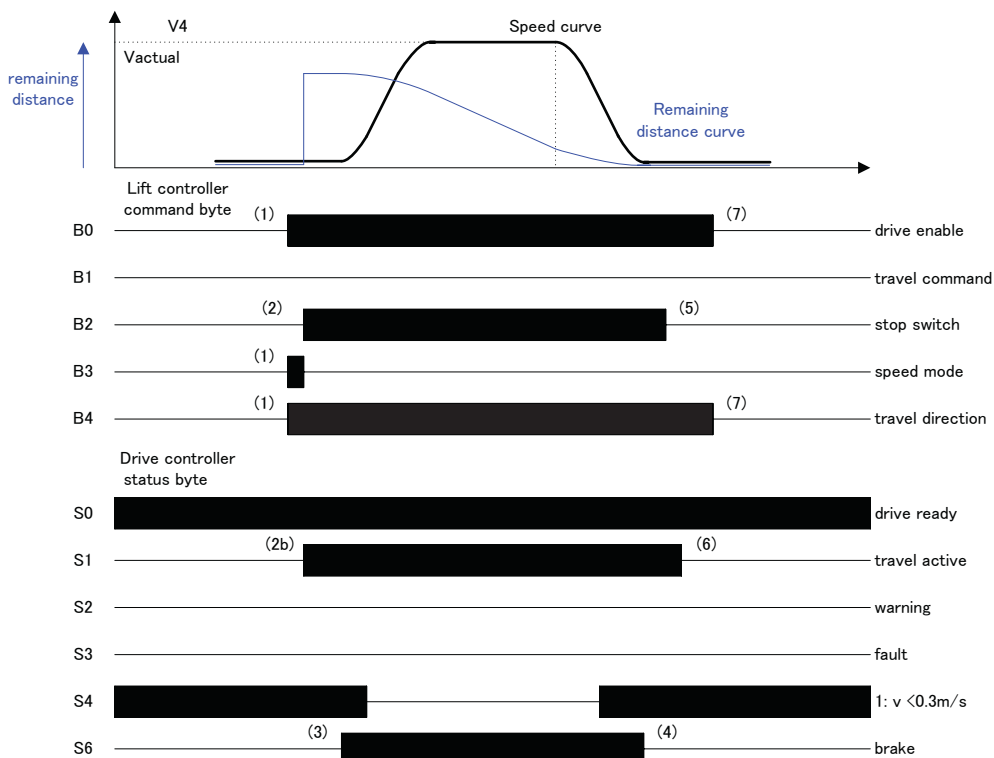

The numbers found in brackets are indicating the chronological order of setting and clearing the individual signals [(1) -> (2) -> (2b) -> (3) etc.]. The sequence (2b) and (2) can occur simultaneously.

Thick signals are considered activated (logical TRUE).

◆ Features Common to DCP3 and DCP4

■ Additional Notes on Command and Status Bits

The following notes apply to DCP3 and DCP4.

Command Bit B0: Drive Controller Enable

Drive controller enable bit B0 must be set whenever the drive shall run.

Drive controller enable bit B0 must be switched off by the lift controller if the safety circuit is interrupted. This is usual when terminating inspection travels. In this case, the drive coasts to stop.

Command Bit B4: Direction

The travel direction must be available throughout the entire travel. The drive decelerates immediately if the setting changes during the travel, but without the drive controller switching to fault.

Status Bit S0: Drive Controller Ready

The lift controller only starts a new travel if the drive controller ready bit S0 is set.

After power on, bit S0 is held active for 4 seconds in order to give the lift controller the opportunity to send an I6='U' telegram to activate reduced undervoltage levels in the drive.

Status Bit S1: Travel-Active Bit

During normal operation, the lift controller switches the motor contactors ON while S1 = '1'. In case of a regular halt, the drive controller should not set S1 from '1' to '0' before S6 is set to '0', and the lift controller has had time to close the mechanical brake.

Status Bit S2: Alarm Active

If re-starting is performed although this bit is set, an error message is sent to the drive controller (DOE1, DCP Operation Error 1).

The lift controller only starts a new travel if the alarm active bit S2 is reset. If S2 is activated during the travel, the lift controller should no longer extend the remaining distance.

Status Bit S6: Mechanical Brake

In case of a regular start, the drive controller should set S6 from '0' to '1' after the Brake Open Delay Time S1-06.

In case of a regular halt, the drive controller should set S6 from '1' to '0' when it has stopped completely. In this situation, the drive controller should hold the torque for about 100 ms (S1-07 = 100 ms), so that the lift controller can close the mechanical brake without coasting of the drive.

Status Bit S3: Fault Active

When general fault bit S3 is activated, drive controller enable bit B0 has to be reset. The lift controller must not start a new travel until fault active bit S3 has been reset. The stopping method is according to b1-03.

■ Travels

These travels are common for DCP3 and DCP4.

Inspection Travel

Inspection Travel with VI

1. The speed mode "Inspection [bit G4]" (VI) is transmitted before the travel starts.
2. The travel starts with activation of travel command bit B1 and stop switch bit B2.
3. When the lift arrives at one of the end-stops, the lift controller switches off travel command bit B1 in order to start its deceleration ramp. If the stop switch bit B2 is still active, the drive continues to travel at crawl speed (V0).
4. Releasing the inspection button generally opens the safety circuit. That is why an electrical stop is not possible. When the inspection function is deactivated, the lift controller must switch off drive controller enable bit B0.
5. When a stop command is received during leveling speed, the drive should use C1-02 ramp to stop as for nominal travel.

Figure 8 Inspection Travel stopped with Idle Command

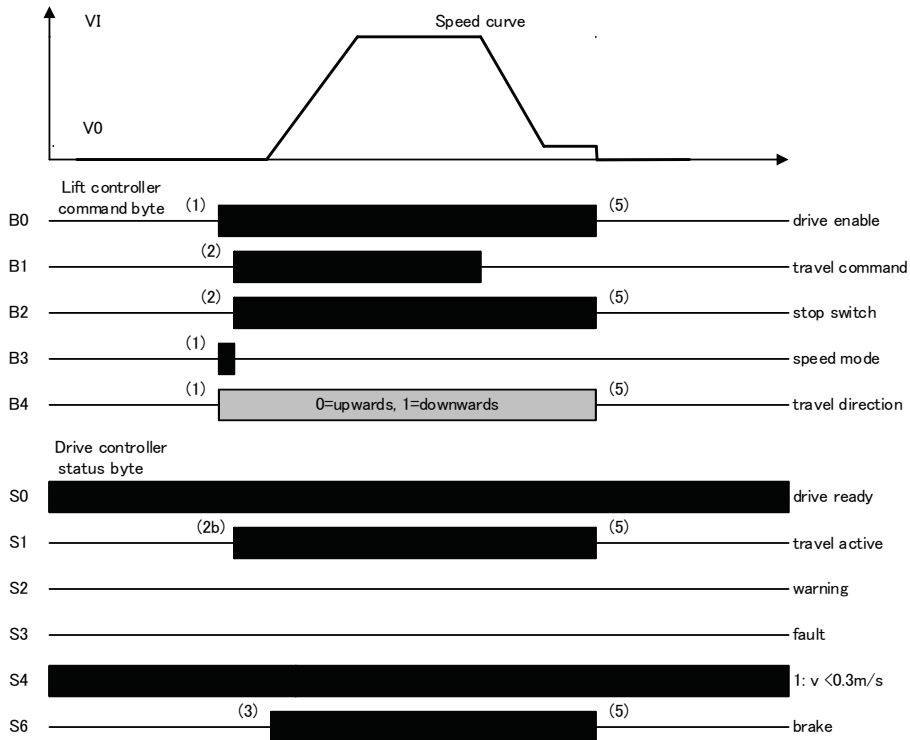
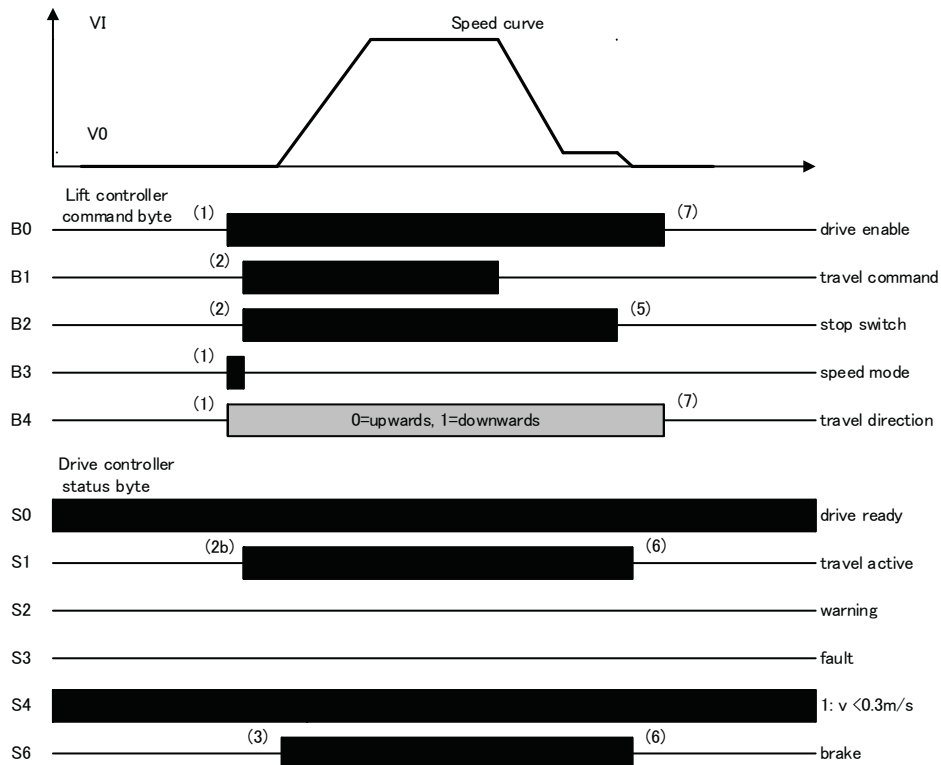

Figure 9 Inspection Travel stopped with Stop Command



Inspection Travel with V0

When the car is standing in the range of the end-stops, an inspection travel towards the end may not start with inspection speed (VI). In this case, it must start with crawl speed (V0). This is realized by activating only stop switch bit B2 without activating travel command bit B1.

Note: Just like the inspection travel with VI, the speed mode "Inspection [bit G4]" (VI) is transmitted before the travel starts.

This is necessary because some types of drive controllers in DCP4 mode can only realize an inspection travel with V0 if the "Speed Mode" command is using the speed inspection bit G4 (VI).

1. The Speed Mode "Inspection [bit G4]" (VI) is transmitted before the travel starts.
2. The travel starts with activation of stop switch bit B2.
3. During the time the stop switch bit B2 is still activated, the drive continues to travel at crawl speed (V0).
4. Releasing the inspection button generally opens the safety circuit. That is why an electrical stop is not possible. When the inspection function is deactivated, the lift controller must switch off drive controller enable bit B0.
5. When during leveling speed a stop command is received, the drive should use C1-02 Ramp to stop as for a normal crawl travel.

Figure 10 Inspection Travel with V0 and stopping with Idle Command

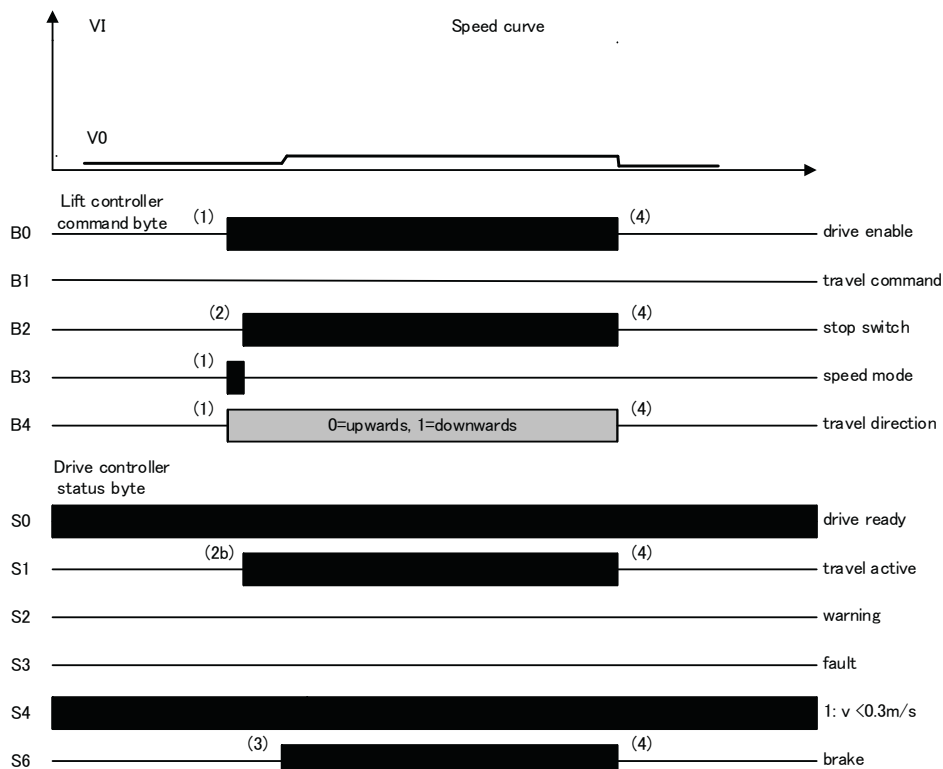
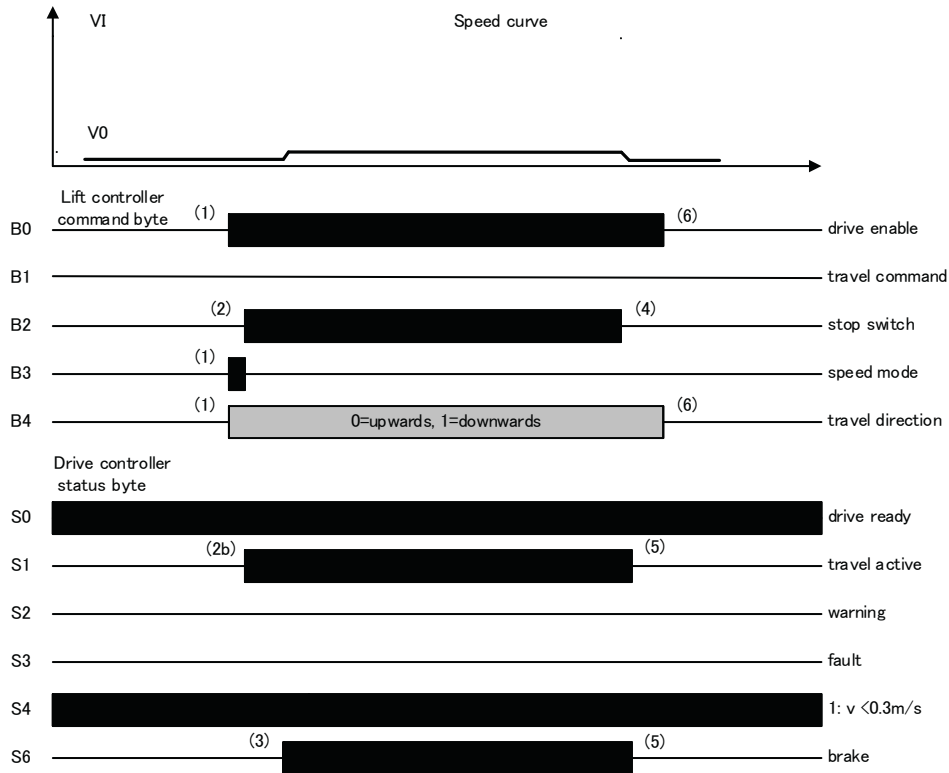

Figure 11 Inspection Travel with V0 and stopping with Stop Command



Re-leveling Travel not Dependent on Remaining Distance

The re-leveling travel not depending on remaining distance is used for DCP3 and in special cases for DCP4. With DCP4, re-leveling travel dependent on remaining distance is also applied.

Re-leveling Travel not Dependent on Remaining Distance without Electric Stop

Many lift controllers treat re-leveling as a special case. The mechanical brake and the motor contactors are also switched off along with the re-leveling speed (see step (3)).

1. Before the travel starts, the speed mode "Releveling [bit G1]" (VN) is transmitted.
2. The travel starts with activation of travel command bit B1, but the stop switch is not set.
3. Travel command bit B1 and drive controller enable bit B0 are switched off at the same time.

Figure 12 Re-leveling Travel without Electric Stop (DCP3)

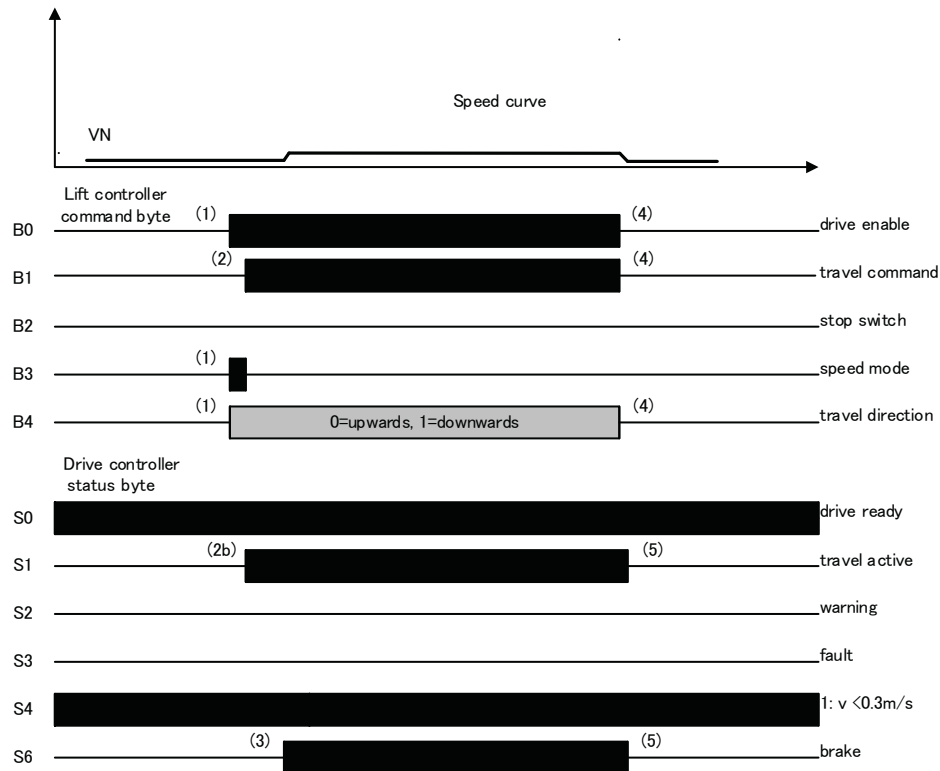

If the drive controller enable is not switched off, the motor contactors will be carrying current when opened.

Since the motor is not being supplied with power during the time elapsing until the mechanical brake is applied, the drive can coast. Therefore, the method described in the next section is of advantage.

Re-leveling Travel not Dependent on Remaining Distance with Electric Stop

The following method allows smooth stopping:

1. Before the travel starts, the speed mode "Releveling [bit G1]" (VN) is transmitted.
2. The travel starts with activation of travel command bit B1, but the stop switch is not set.
3. After the travel command bit B1 has been switched off, drive controller enable bit B0 remains activated. The drive decelerates to 0 and holds the car until the mechanical brake is applied.
4. Drive controller enable bit B0 and the motor contactors are not switched off until the mechanical brake bit S6 and travel activated bit S1 are switched off.

Figure 13 Re-leveling Travel with Electric Stop

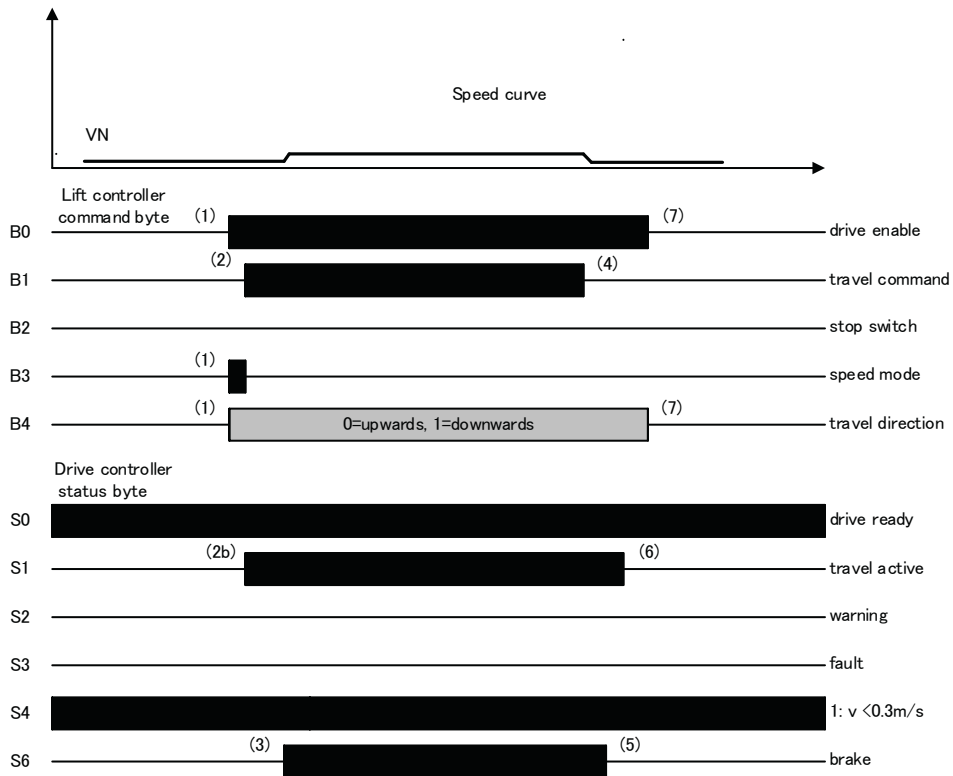

◆ DCP3: Lift Controller without Absolute Sensor System

■ Travels at V4 followed by Constant Deceleration Distance SV4

Long Travel at High Lift Speed V4

1. Before the travel starts, the speed mode "Fast [bit G7]" (V4) is transmitted.
2. The travel starts with activation of travel command bit B1.
3. After the travel command has been switched off, the drive decelerates to crawl speed within the fixed distance SV4. The distance is supplied by the motor's incremental encoder. Stop switch bit B2 must be activated not later than at this point in time.
4. The lift controller positions the lift car with the stop switch bit B2.
5. The lift controller switches the travel contactors off when the drive controller ends the travel at S1 = 0.

Figure 14 V4 Long Travel (DCP3)

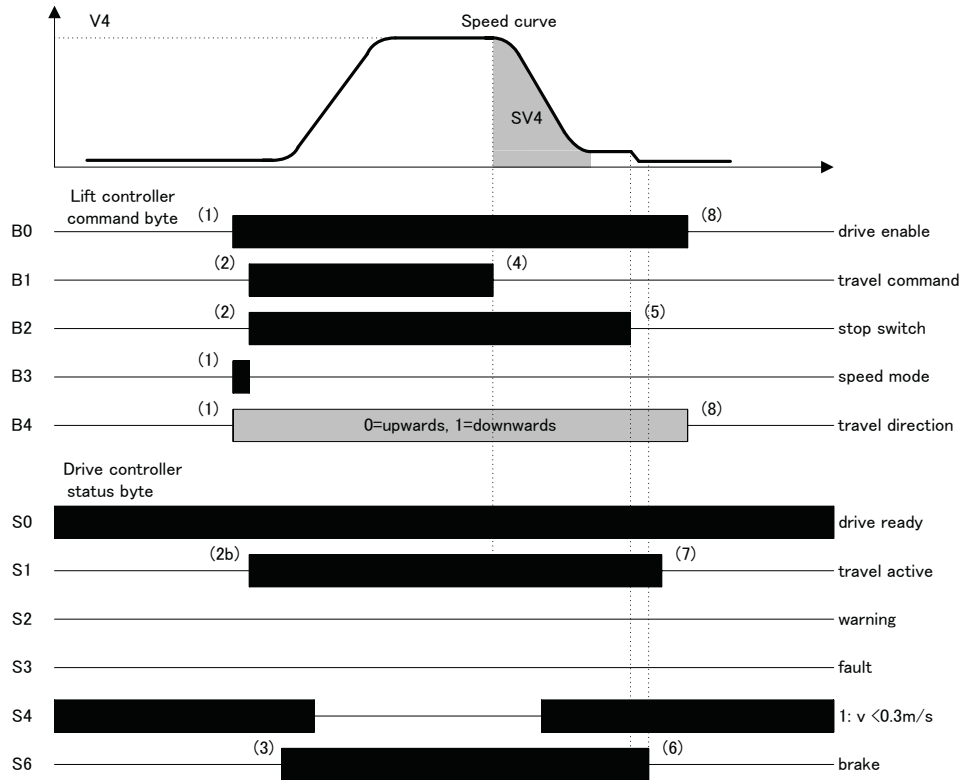

Time-Optimized Short Travel at Lift Speed V4

1. Before the travel starts, the speed mode "Fast [bit G7]" (V4) is transmitted.
2. The travel starts with activation of travel command bit B1.
3. In contrast to above sequence, travel command bit B1 is switched off before fast speed (V4) is reached. The same fixed remaining distance (SV4) as for the long travel is traversed when slowing down to crawl speed (V0).

Figure 15 V4 Short Travel (DCP3)

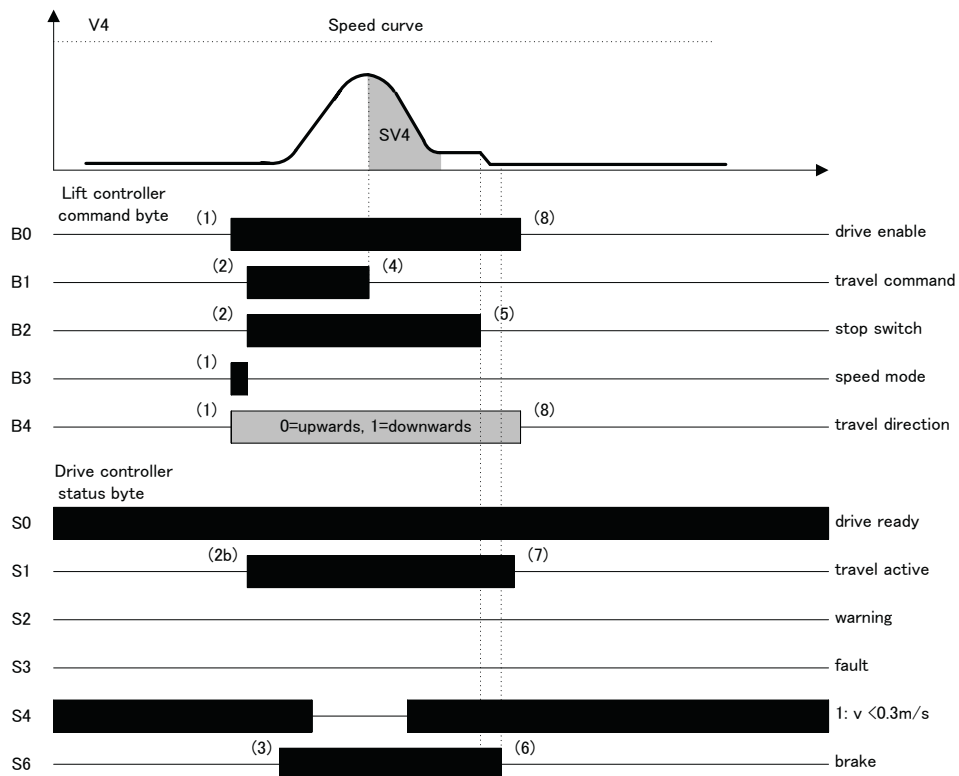

■ Travels at Intermediate Speeds V7, V6, V5, V3, V2, and V1

Long Travel at Intermediate Speed

The same procedure as in the previous chapter with fast speed applies whereas in step (1), the appropriate intermediate speed must be transmitted. The deceleration distance is dependent on the selected speed.

- V3 (Intermediate 1 [Bit G6]) > SV3
- V2 (Intermediate 2 [Bit G5]) > SV2
- V1 (Intermediate 3 [Bit G3]) > SV1
- V7 (Intermediate 4 [Bit G10]) > SV7
- V6 (Intermediate 5 [Bit G9]) > SV6
- V5 (Intermediate 6 [Bit G8]) > SV5

Time-Optimized Short Travel at Intermediate Speed

The same procedure as described in chapter *Time-Optimized Short Travel at Lift Speed V4 on page 39* with fast speed applies whereas in that step (1), the appropriate intermediate speed must be transmitted.

■ Crawl Travel in DCP3

1. Before the travel starts, the speed mode "Crawl [bit G0]" (V0) is transmitted.
2. The travel starts with activating the travel command bit B1 and the stop switch bit B2.
3. After travel command bit B1 and the stop switch bit B2 have been reset, the drive decelerates.
4. Drive controller enable bit B0 must not be switched off until the mechanical brake bit S6 and the motor contactor bit S1 have been switched off.

Figure 16 Crawl Travel (DCP3)

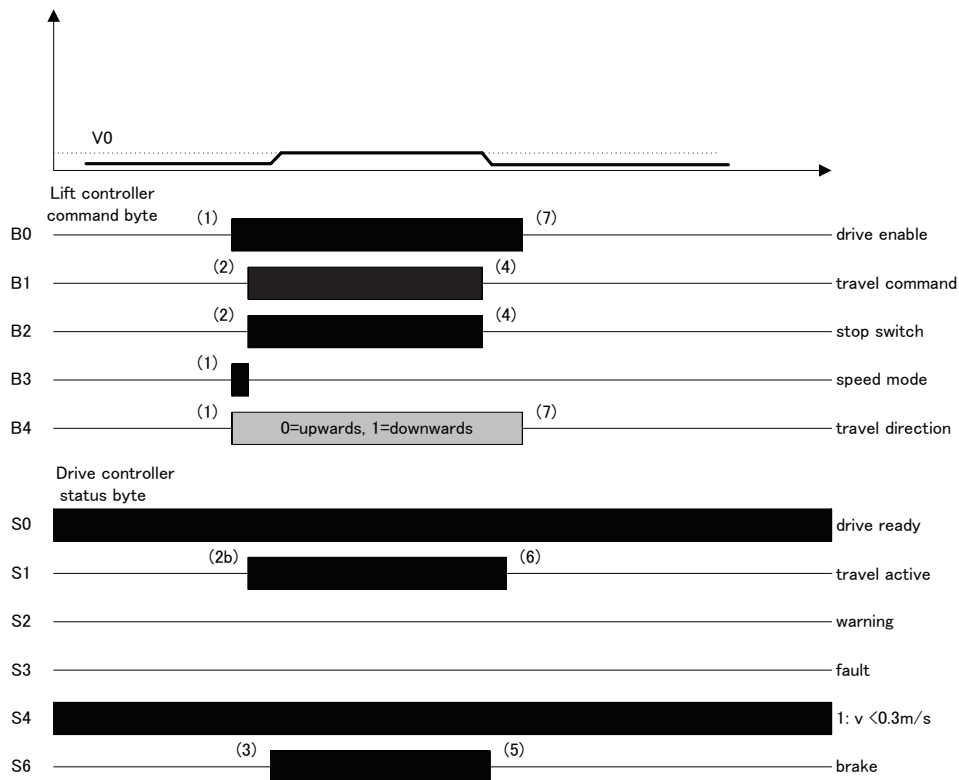

Note: The lift can also be operated without travel command bit B1. For travels with stop switch bit B2 only, the speed selection is automatically set to crawl speed V0. B1 can be set or reset at any time. The important bit for crawl travel is B2.

◆ DCP4: Lift Controller with Absolute Sensor System

With DCP4, travels are normally carried out time-optimized and dependent on remaining distance. Furthermore, travels not dependent on remaining distance as described later are supported here, allowing special kinds of travels, e.g. teaching travels for the absolute sensor system.

Currently, there are two ways to control a drive using DCP4:

1. DCP4 mode with transfer of desired travel distance and braking distance before start
Before starting, there is a data exchange between controller and drive using message 'I','7'. The drive does not have to be able to transmit the braking distance while driving.
2. DCP4 mode with transfer of current braking distance while driving
Before starting, there is no data exchange by using message 'I','7' telegram. While traveling, the drive permanently sends the actual braking distance.

Figure 17 Travel with Remaining Distance and Actual Braking Distance (DCP4)

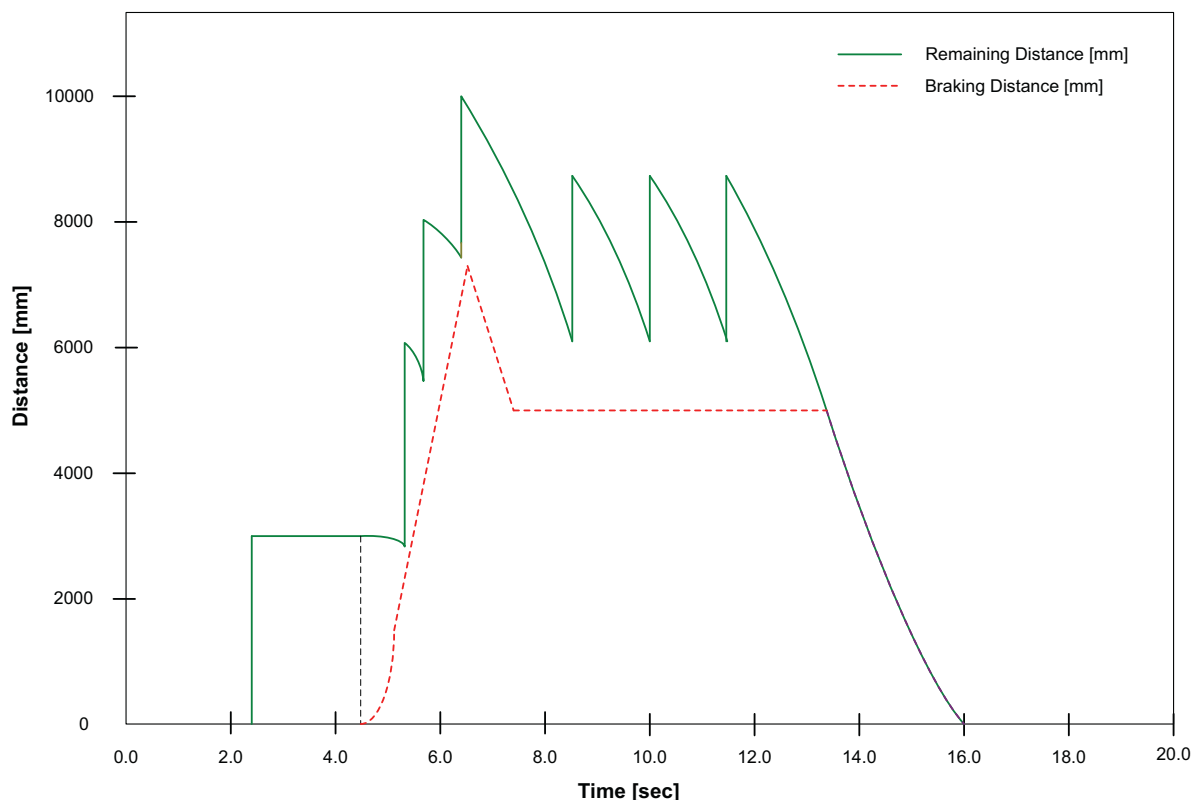

■ Time-Optimized Direct Leveling Dependent on Remaining Distance

Definition and Features of V4', V3', and VN' Travels

With time-optimized travels dependent on remaining distance, there are no points at which lift speeds are switched. Dependent on the distance to be traveled, the corresponding maximum speed V5, V3, or VN may not be reached during the travel. Instead, the optimum speed for reaching the destination is determined. The lift travels to the destination at this speed. To clearly distinguish them from DCP3 travels, the DCP4 mode travels are therefore identified with an apostrophe (').

The travels described below have the following common features:

- Before the travel starts, a preselected speed is transmitted. This is just a limit that the drive controller is not allowed to exceed. The actual value of the speed is decided by the drive controller itself by calculating the time-optimized travel curve based on the actual remaining distance.
- The travels dependent on remaining distance are executed without travel command bit B1.
- Right from the travel start, the absolute remaining distance is read via DCP.
- Stop switch bit B2 remains active until the lift car reaches the level and the drive controller switches the mechanical brake bit S6 off.

V4' Travel

1. Before the travel starts, the speed mode "Fast [bit G7]" (V4) is transmitted
2. The travel starts with activation of the stop switch bit B2. After starting the travel, the absolute remaining distance can be read via DCP.
3. The drive decelerates until the lift car comes to the level without driving crawl speed. The drive controller then switches the mechanical brake bit S6 off.
4. The controller does not withdraw the stop switch bit B2 until mechanical brake bit S6 is switched off. The maximum deceleration distance is SV4'.

Figure 18 V4' Long Travel (DCP4)

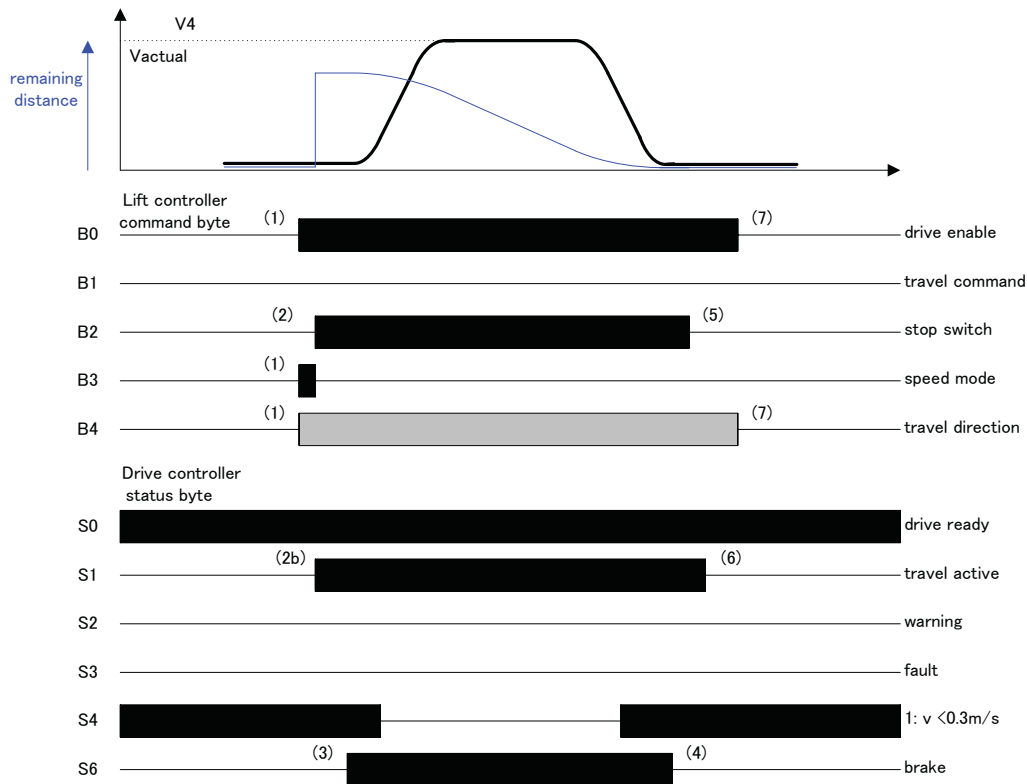

Note: The controller can increase the remaining distance while it is greater than the braking distance the drive controller had transmitted before the beginning of the travel.

Special case: Advantage of DCP4 with time-optimized travel depending on remaining distance:

If, at the start of the travel, a remaining distance is set too short, so that the speed V4 is not possible to reach, the drive controller calculates a time-optimized lift travel curve (pointed arch shape). The initial remaining distance can be very much shorter than the maximum deceleration distance SV4' required.

Figure 19 V4' Short Travel (DCP4)

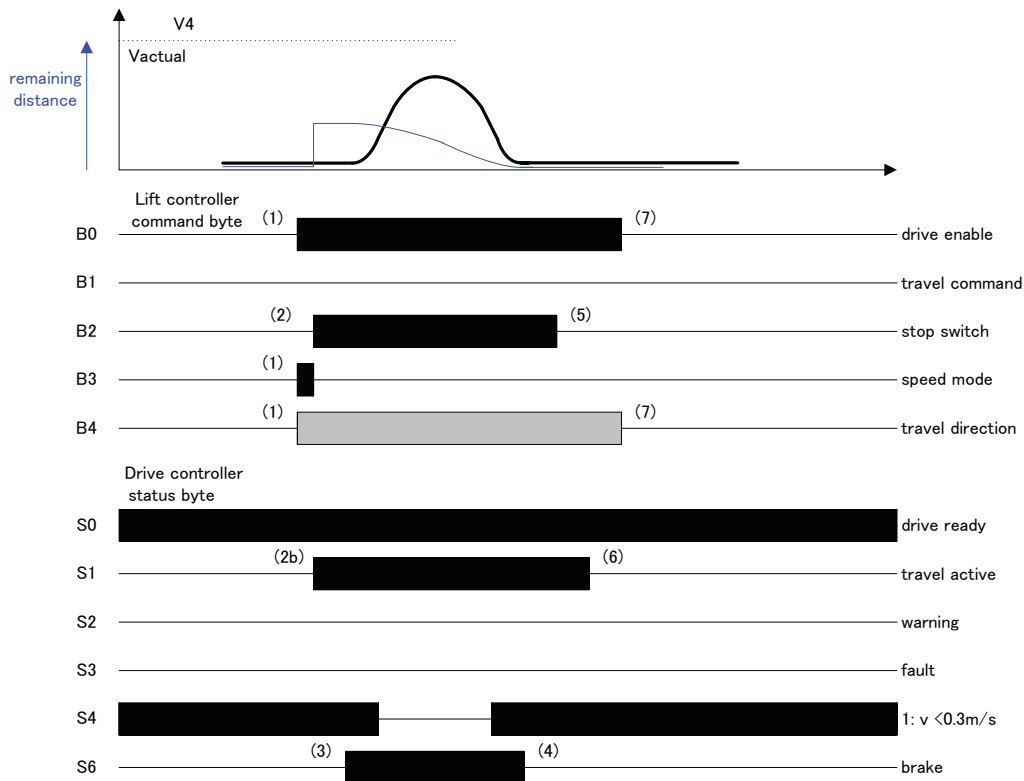

Note: If the remaining distance at the start of travel is less than 20 cm, the drive controller automatically limits the maximum speed to crawl speed (V0).

Exchange of Parameters between Lift Controller and Drive Controller before the Travel

To enable the lift controller to track the floor level correctly and to know which calls it can still accept during a travel, additional information from the drive controller is required. Before starting, the drive controller receives information via communication channel on how far the lift has to travel. It responds by transferring the minimum distance the lift has to travel at the calculated speed and how long the remaining distance has to be to allow an extension.

The messages have the following structure:

- Lift Controller

STX	1Ch	'I'	'7'	V _{max}	Ss1	Ss2	Ss3	Ss4	Ss5	ETX
-----	-----	-----	-----	------------------	-----	-----	-----	-----	-----	-----

V_{max}:

'1' > max. speed is V3

'2' > max. speed is V4

Ss1 ... Ss5:

Desired distance in cm (ASCII coded in BCD format)

- Drive Controller

STX	1Ch	'I'	'7'	f _{typ}	Sg1	Sg2	Sg3	Sg4	Sg5	Sv1	Sv2	Sv3	Sv4	Sv5	ETX
-----	-----	-----	-----	------------------	-----	-----	-----	-----	-----	-----	-----	-----	-----	-----	-----

f_{typ}:

's' short travel

'l' long travel

Sg1 ... Sg5:

Minimum travel distance in cm (ASCII coded in BCD format)

Sv1 ... Sv5:

Deceleration distance in cm (ASCII coded in BCD format)

Travel can be extended if actual remaining distance > Sverz (deceleration distance)

V3' Travel

Same procedure as described in the previous chapter.

Difference: The speed mode "Intermediate 1 [bit G6]" (V3) is transmitted. This limits the speed to V3.

Application: For short travels also, the lift can be operated with preselected speed V4 as described before. In cases in which it is desirable to limit the speed, V3 can be used.

VN' Re-leveling Travel Depending on Remaining Distance

The usual method of re-leveling is often just a compromise. With DCP4, however, commanding the remaining distance makes re-leveling accurate to the millimeter.

1. Before the travel starts, the speed mode "Releveling [bit G1]" (VN) is transmitted.
2. The travel starts with activation of stop switch bit B2. From the start of the travel, the absolute remaining distance is read via DCP.
3. The drive decelerates dependent on the remaining distance until the lift car reaches the exact floor position.
4. The lift controller does not withdraw the stop switch bit B2 until the mechanical brake bit S6 is switched off.
5. The lift controller must not switch off the drive controller enable bit B0 until the end of the travel S1=0.

Figure 20 VN' Re-leveling Travel (DCP4)

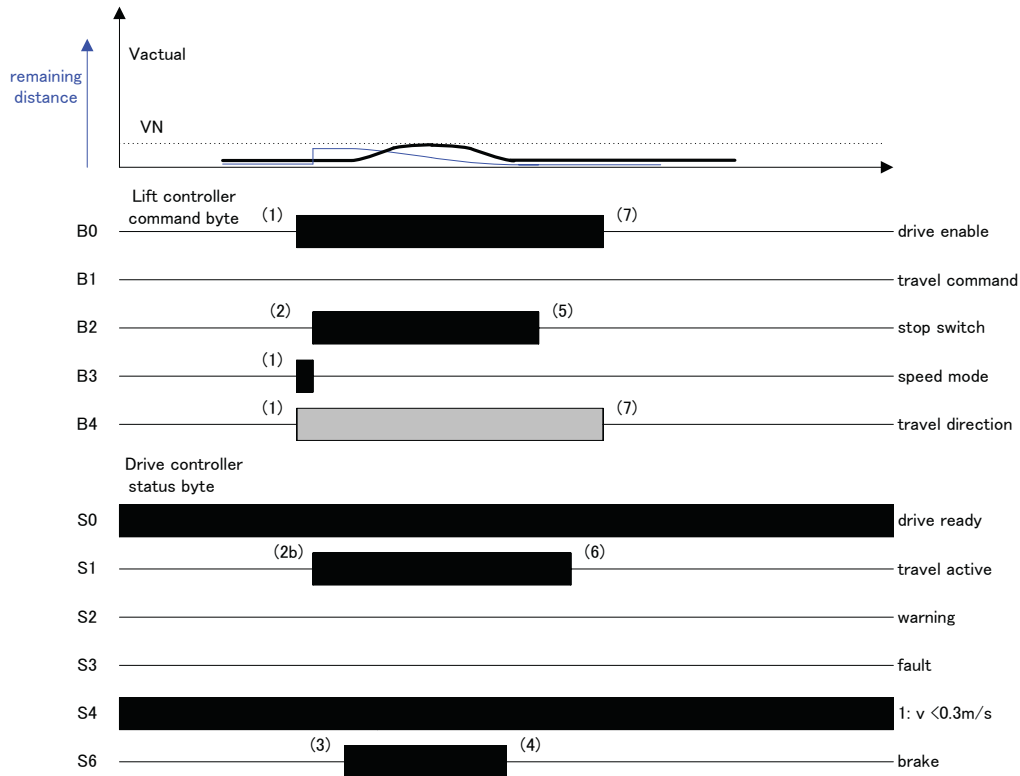

■ Crawl Travel in DCP4

There is no definition of a crawl travel sequence in DCP4. The lift controller chooses one of the described travel sequences dependent on the remaining distance.

Exception:

- If the remaining distance at start is less than 20 cm, the drive controller limits the maximum speed to crawl speed.
- The inspection and rescue travels are independent of the DCP3 and DCP4 modes. In this case, the speed is limited to crawl speed when the lift levels at the end stop.

◆ DCP Fast-Start Function

The 'Fast-Start Function' allows magnetizing the motor already when the doors are closing and holding the lift car with opened brake in the level position. This function can be used with DCP3 and DCP4. If the 'Fast-Start Function' is active and the doors are completely closed, the car can immediately start moving without losing time for magnetizing the motor and opening the brakes.

Note: Some additional wirings and shaft signals are necessary to meet the requirements of the EN81-1.

■ Start Sequence

The following figure shows the start sequence for DCP3 and DCP4.

Figure 21 Fast-Start Sequence DCP3

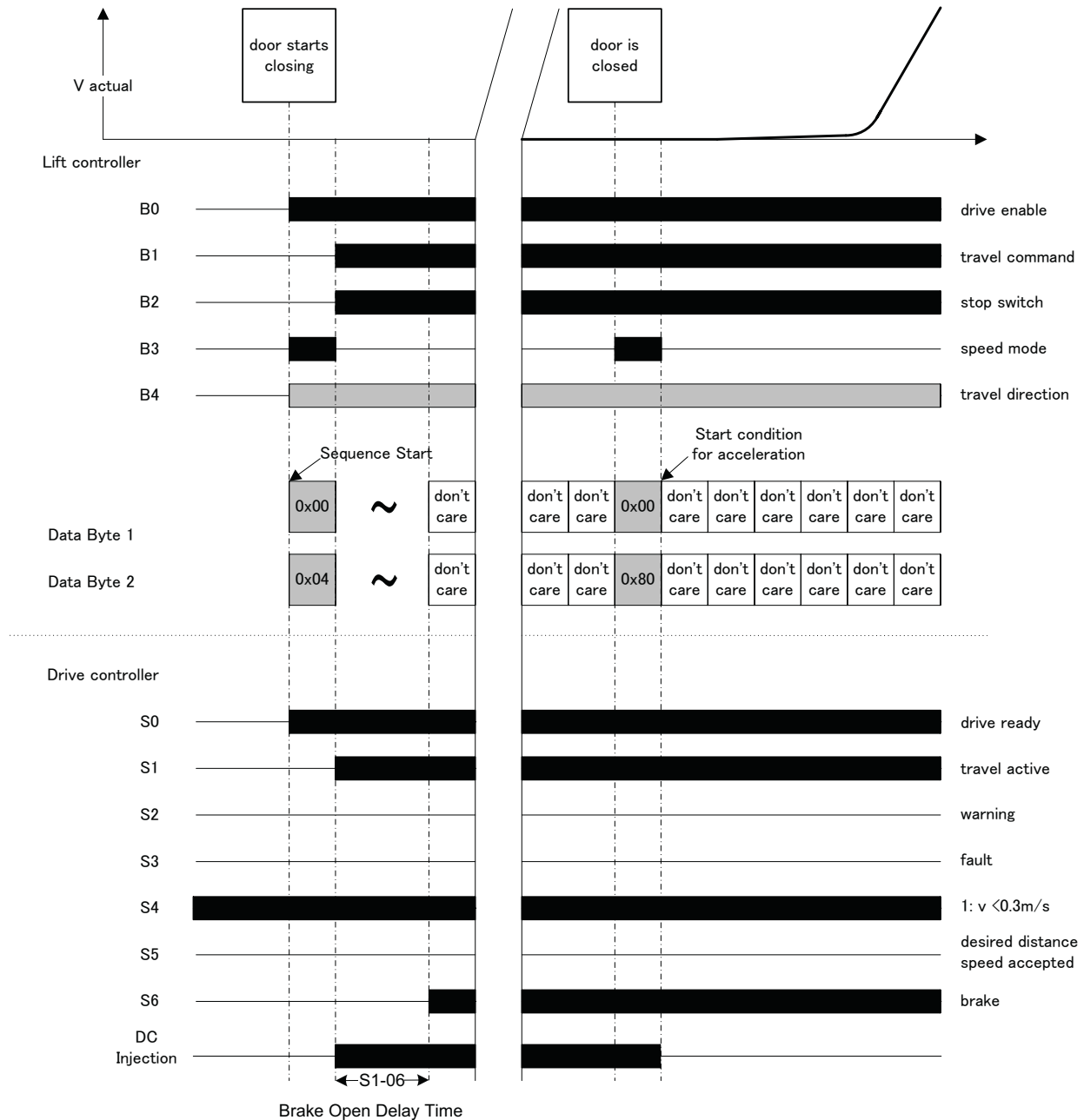
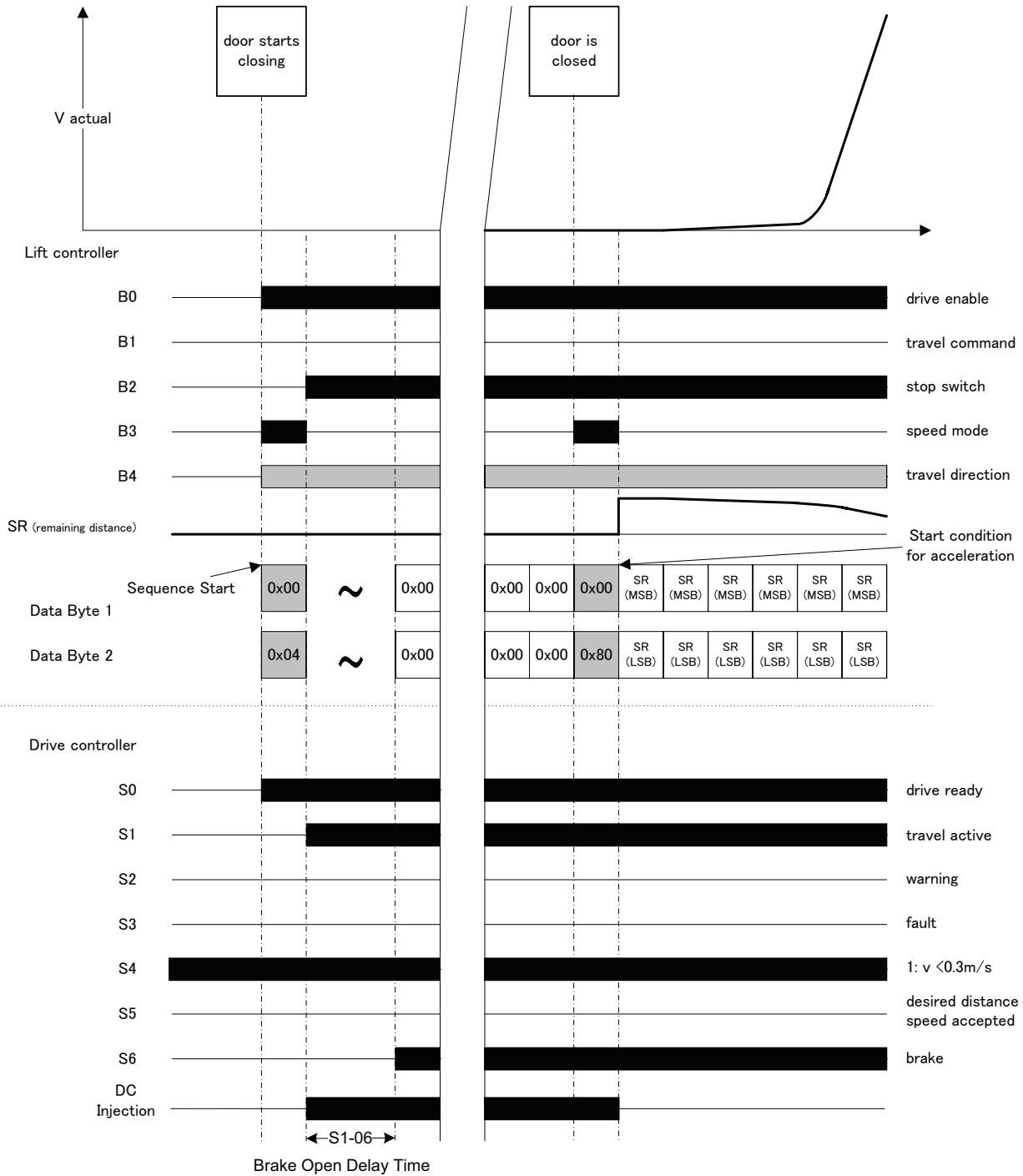

Figure 22 Fast-Start Sequence DCP4



Activation of the 'Fast Start Function'

The 'Fast-Start Function' is activated when the travel sequence starts with a speed message (B3=1, B2=0, B1=0, B0=1) using speed mode VF (4h) in the lift controller's data bytes.

Actions and Controls during 'Fast-Start Function'

When the 'Fast-Start Function' is active, the inverter applies DC-Injection / Zero-Servo to hold the car in position while the brakes are opened by the drive controller. The time during which the 'Fast-Start Function' is active should be limited and monitored on lift controller side.

Transition from 'Fast-Start Function' to Normal Travel

An additional speed message (DCP3: B3=1, B2=1, B1=1, B0=1; DCP4: B3=1, B2=1, B1=0, B0=1) with a regular speed mode in the lift controller's data bytes terminates the 'Fast-Start Function' and initiates the normal travel with the selected speed.

■ Premature Termination of the 'Fast-Start Function'

There are some situations where it is necessary to abort the 'Fast-Start Function'. Examples for these situations are:

- The doors are reversing (opening again).
- A time-out occurs (e.g. the doors can't be closed because they are blocked).
- A fault occurs (e.g. motor thermistor or a leaving of the door zone).

In principle, there are two ways how the 'Fast-Start Function' can be aborted:

- Immediate termination regardless of the state of the drive controller's status bit S6 'mechanical brake'.
- Premature termination considering the state of the drive controller's status bit S6 'mechanical brake'.

Immediate Termination Regardless of S6 'Mechanical Brake' Status

The 'Fast-Start Function' can be terminated immediately by clearing the lift controller's command byte.

Note: A termination of the 'Fast-Start Function' regardless of the state of the drive controller's status bit S6 'mechanical brake' can cause a drifting of the car and a disconnection of the main contactors under load. Therefore, whenever possible, termination considering the state of the drive controller's status bit S6 'mechanical brake' should be preferred.

Figure 23 Immediate Termination of Fast-Start Sequence DCP3

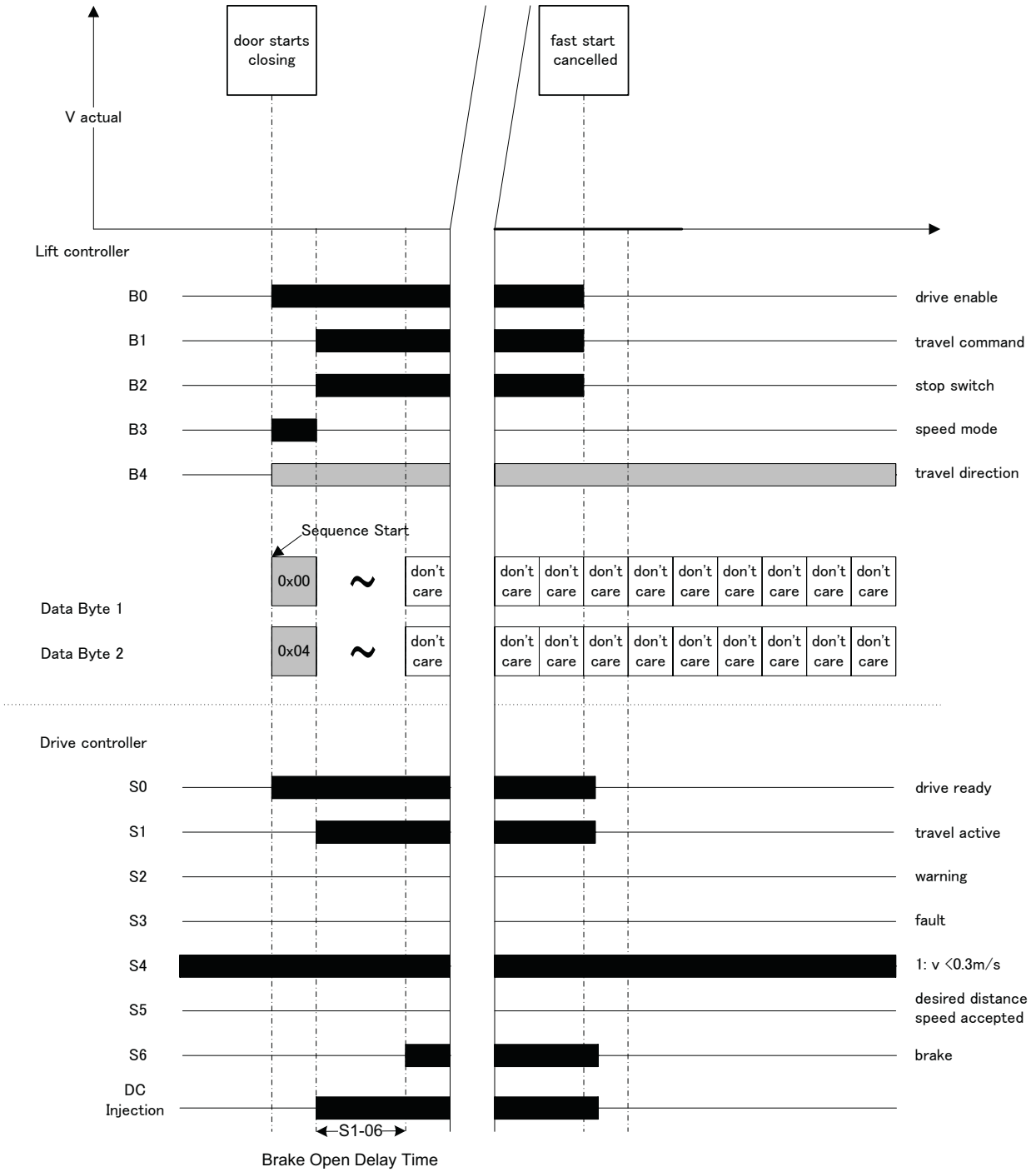
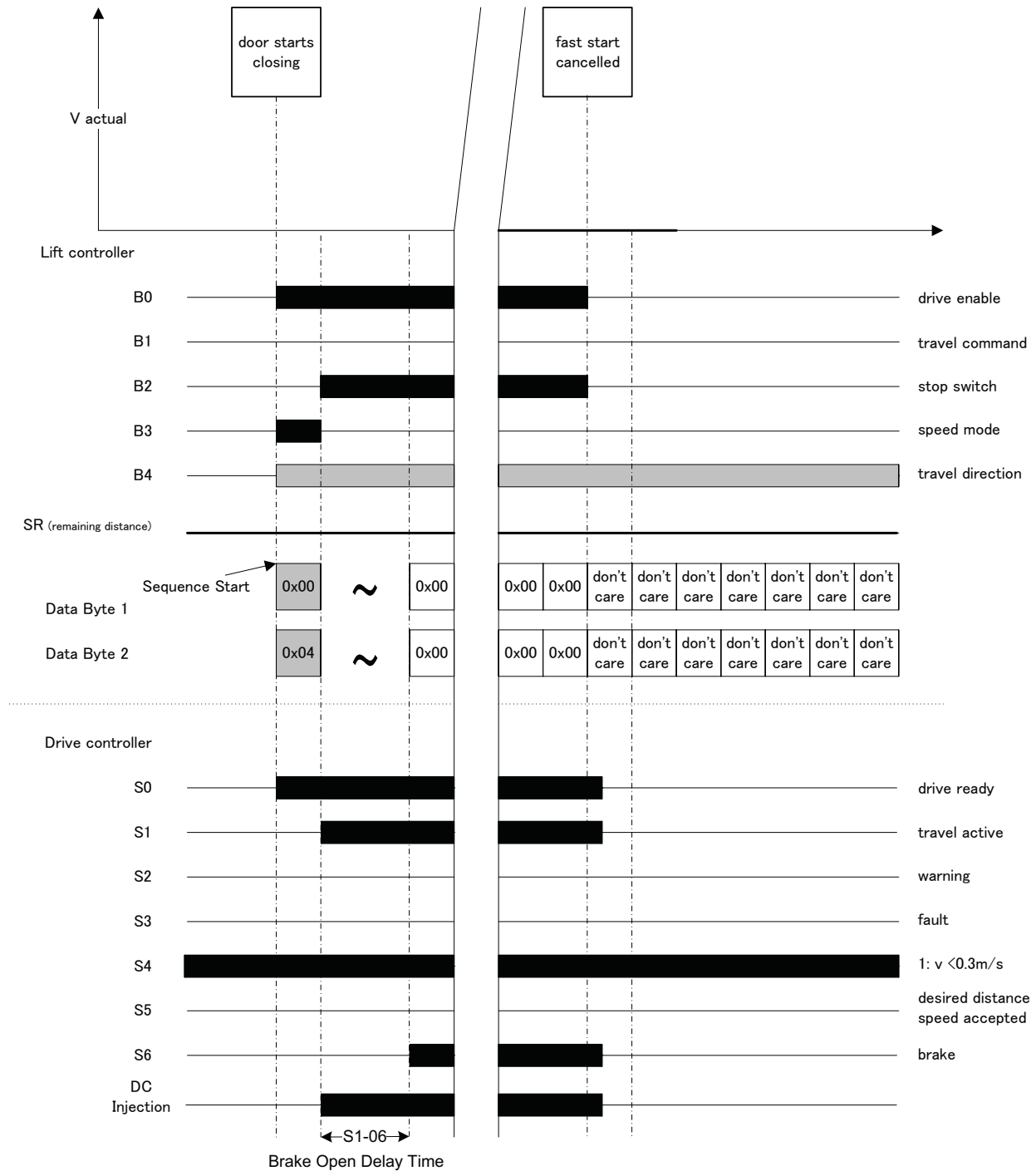

Figure 24 Immediate Termination of Fast-Start Sequence DCP4



Premature Termination Considering S6 'Mechanical Brake' State

The controlled premature termination of the 'Fast-Start Function' is initiated by a stop message (B2=0, B1=0, B0=1). This will cause the drive controller to immediately close the brakes. After completing the brake sequence and demagnetizing the motor, the drive controller or lift controller opens the main contactors.

Whenever possible, the lift controller should use this method for premature termination as it prevents the car from drifting and the main contactors from disconnecting under load.

Figure 25 Premature Termination DCP3

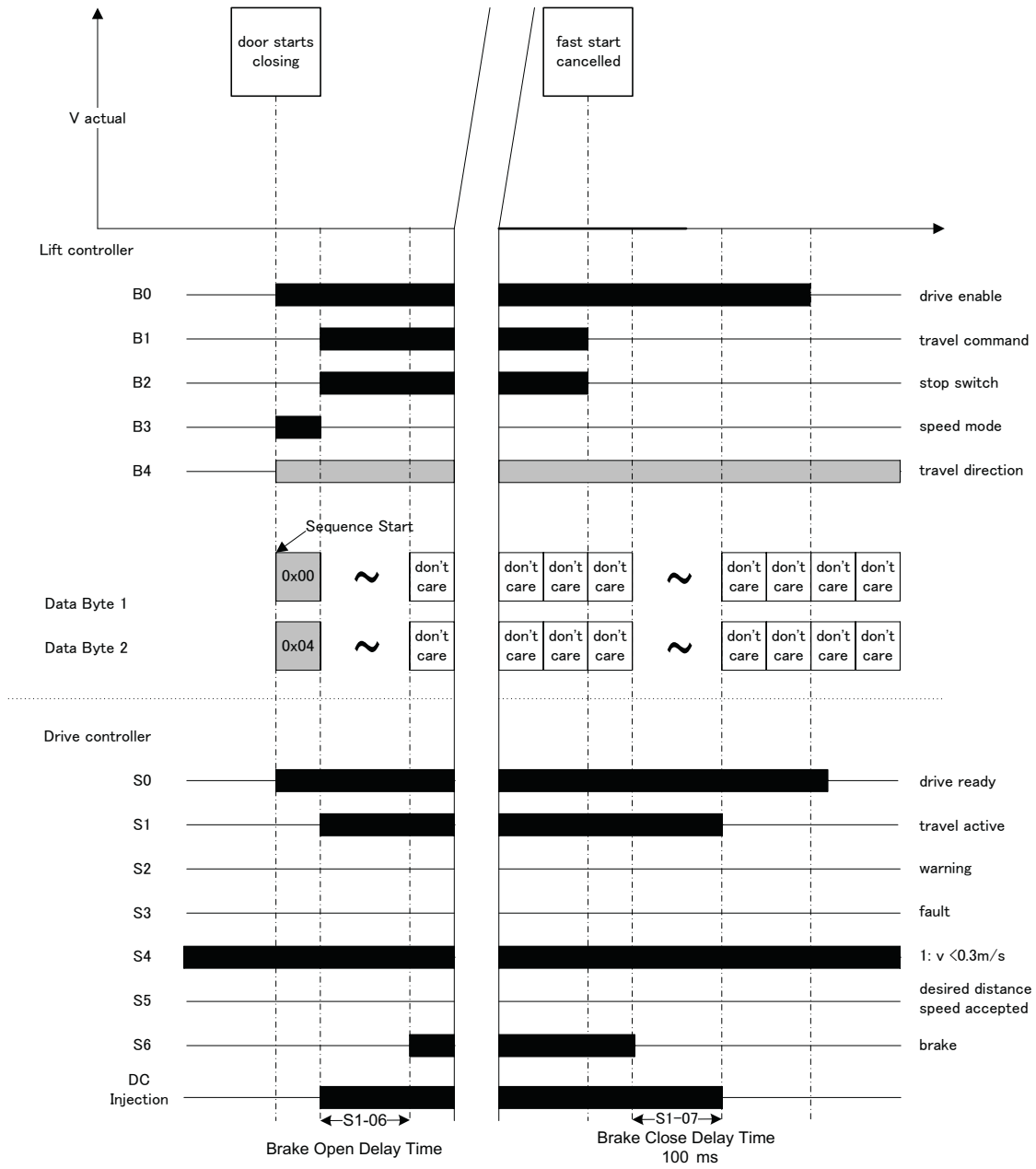
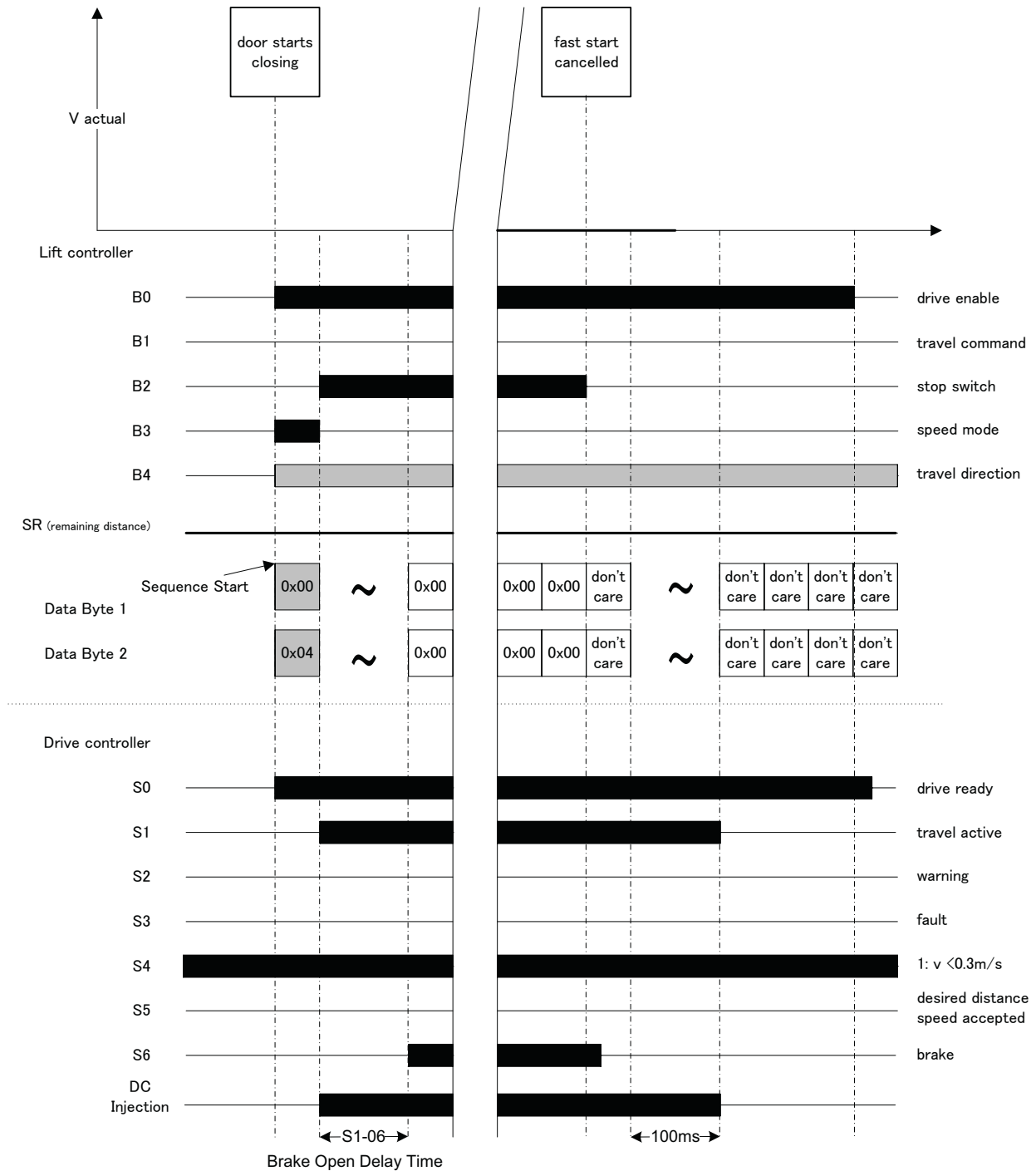

Figure 26 Premature Termination DCP4



◆ DCP Fast-Stop Function

The Fast-Stop Function stops the motor with a dedicated Fast-Stop ramp. It can be used to position the car during commissioning or as failure reaction after an identified malfunction. The electrical braking method is often faster than stopping with mechanical brake.

The functionality is independent of operation mode DCP3 or DCP4.

■ Activation of the Fast-Stop Function

The control of the Fast-Stop Function is based on the Fast-Start function control.

The Fast-Stop function is activated using an additional speed mode command (DCP3: B3=1, B2=1, B1=1, B0=1; DCP4: B3=1, B2=1, B1=0, B0=1) during the travel, applying speed VF (4h) in the data bytes.

■ Executing the Fast-Stop Function

After activation of the Fast-Stop function, no other travel command will be accepted and the motor stops with the Fast-Stop ramp (C1-09). When Zero-Speed is reached, the mechanical brake will be applied.

Note: The Fast-Stop function is no safety function. If safety requirements have to be applied, the deceleration has to be monitored by an auxiliary safety system.

◆ DCP Overview Diagrams

Master Message (lift controller)																																															
byte 1								byte 2								byte 3								byte 4				byte 5				byte 6															
command byte								data byte 1								data byte 2								comm. byte 1				comm. byte 2				checksum															
B7	B6	B5	B4	B3	B2	B1	B0	D15	D14	D13	D12	D11	D10	D9	D8	D7	D6	D5	D4	D3	D2	D1	D0																								
error in last replay message								16bit-remaining distance (only in DCP4 if command byte B3 = '0' and data-information is set to '3')																extended data communication remote keypad control				extended data communication remote keypad control				the checksum is the result of an XOR operation of the bytes: byte 1, byte 2, byte 3, byte 4 and byte 5															
distance (0: actual, 1: desired)								MSB								LSB																															
speed change								15bit-remaining distance (only in DCP4 if command byte B3 = '0' and data-information is set to '0', '1' or '2')								MSB																				LSB											
travel direction (0 = up, 1 = down)																speed mode (if command byte B3 = '1')								MSB								LSB															
speed mode																																															
v0 off switch																																															
travel command (only in DCP3)																																															
drive controller enable																																															

speed mode (encoded in data byte 1 and 2 when bit 3 is set in the command byte)															
data byte 1 (MSB)								data byte 2 (LSB)							
0x80	0x40	0x20	0x10	0x08	0x04	0x02	0x01	0x80	0x40	0x20	0x10	0x08	0x04	0x02	0x01
-	-	-	-	-	V7 Intermediate 4	V6 Intermediate 5	V5 Intermediate 6	V4 fast	V3 Intermediate 1	V2 Intermediate 2	V1 Inspection	V1 Intermediate 3	VF Fast start/stop	VN reveling	VO crawl

Slave Message (drive controller)																																															
byte 1								byte 2								byte 3								byte 4				byte 5				byte 6															
status byte								data byte 1								data byte 2								comm. byte 1				comm. byte 2				checksum															
S7	S6	S5	S4	S3	S2	S1	S0	D15	D14	D13	D12	D11	D10	D9	D8	D7	D6	D5	D4	D3	D2	D1	D0																								
error in last replay message								16bit-remaining distance (if data-information is set to '3')																extended data communication remote keypad control				extended data communication remote keypad control				the checksum is the result of an XOR operation of the bytes: byte 1, byte 2, byte 3, byte 4 and byte 5															
open mechanical brake								MSB								LSB																															
desired distance/speed accepted								0								15bit-remaining distance (if data-information is set to '0' or '1')																				MSB								LSB			
0: v>=0,3m/s; 1: v<0,3m/s																15bit-remaining distance (if data-information is set to '0' or '2')								MSB								LSB															
general fault active																																															
advanced warning active																																															
travel active																																															
drive controller ready																																															
-								not used																																							
								not used																																							
								drive over temperature																																							
								not used																																							
								recommended direction																																							
								reduced interm.circ.-volt.																																							
								reserved																																							
								reserved																																							
								reserved																																							
								reserved																																							
								reserved																																							
								reserved																																							
								over speed (0: >=; 1: <)																																							
								bord. speed (0: >=; 1: <)																																							
								0:v>=0,8m/s; 1:v<0,8m/s																																							

◆ Related Parameters and Functions

■ Added Standard Parameters

Parameter	Operator Display	Description	Value Range	Default Value
d1-30	Border Speed	If inverter speed exceeds this speed, bit 1 of DCP Extended Status is set.	0.0 ... 150.0%	120.0%
d1-31	Over Speed	If inverter speed exceeds this speed, bit 2 of DCP Extended Status is set.	0.0 ... 150.0%	120.0%
H5-13	Serial Comm Mode	0: DCP Communication Channel 1: Memobus/Modbus 3: DCP3 4: DCP4 5: CANopen-Lift Perform a power cycle when changing the Serial Communication Mode (H5-13)	0, 1, 3, 4, 5	1
S3-05	ZSV Max Speed	Sets the maximum speed allowed during ZeroServo correction	0.00 ... 10.00%	0.00%

■ Added Parameters for Positioning Mode (H5-13 ≥ 4)

This table applies for DCP4 and CANopen-Lift in Profile Position mode.

Parameter	Operator Display	Description	Value Range	Default Value
S7-01	In Pos Width	If remaining distance of the shaft is smaller or equal to the In-Position Width for the In-Position Time, the inverter sets the In-Position bit. The S6 bit for DCP controller is reset after S1-07. In-Position check ends with S1-07. The controller closes the brake if S6 bit is reset.	o1-12 = 0: 0 ... 10 mm	3 mm
			o1-12 = 1: 0.00 ... 0.39 in	0.12 in
S7-02	In Pos Time		0.00 ... 5.00 s	0.60 s
S7-08	ShftInp FltrTme1	Sets the input filter time of the Shaft Encoder position error signal. This is a first order lag filter.	0.00 ... 50.00 s	0.00 s
S7-09	Shaft P Gain	Sets the proportional gain of the Shaft Encoder position controller in quadrature pulses / mm.	0 ... 10,000 qpls/mm	10 qpls/mm
S7-10	Shaft I Time	Sets the integral time of the Shaft Encoder position controller.	0.00 ... 500.00 s	0.00 s
S7-11	Shft FltrTme	Sets the filter time of the Shaft Encoder position controller output. This is a first order lag filter.	0.00 ... 50.00 s	0.00 s
S7-12	Shaft PI Limit	Set the PI limit (+/-) of the Shaft Encoder position controller output. Set in quadrature pulses / ms.	0 ... 1000 qpls/ms	1000 qpls/ms
S7-13	Shft Output Gain	Sets the output gain of the Shaft Encoder position controller.	0.00 ... 100.00	2.00
S7-14	ShftFltrTmeZSV	Low-pass filters the shaft error value before feeding it into Zero Servo position lock controller.	0.00 ... 50.00 s	0.00 s
S7-15	Distance Gain 1	Sets the reduction ratio of commanded distances. It refers to Correction Area 1 (S7-16).	-9.999 ... 9.999%	0.000%
S7-16	Correction Area1	Defines the area or distance during which Distance Gain 1 (S7-15) is applied.	o1-12=0: 0.1 ... 1000.0 m	0.1 m
			o1-12=1: 1 ... 39370 in	1 in
S7-17	ShftInp FltrTme2	Defines the, usually larger, filter time 2 for the shaft error input value which becomes effective below the Shaft Filter Switch Level (S7-18).	0.00 ... 50.00 s	0.00 s
S7-18	ShftFilSwitchLvl	Sets the level below which Shaft Filter Time 2 (S7-17) is applied. This functions helps to rule-out swings of the lift car when running into level position.	0.00 ... 10.00 Hz	2.00 Hz
S7-30	Shaft Pos Trim	Trims the final shaft position by some mm by adding this value to the actual lift car position feedback.	o1-12 = 0: -10 to 10 mm	o1-12 = 0: 0 mm
			o1-12 = 1: -0.39 .. 0.39 in	o1-12 = 1: 0.00 in

Parameter	Operator Display	Description	Value Range	Default Value
S7-31	Min. Prol. Jump	Distance prolongations are only accepted when they exceed S7-31 value. Note: This parameter is not used in CAN-Lift.	o1-12 = 0: 0 to 50 mm	o1-12 = 0: 30 mm
			o1-12 = 1: 0.00 .. 2.00 in	o1-12 = 1: 1.18 in
S7-32	ShD Auto-Tuning	Enables Sheave Diameter Auto-Tuning. After every profile positioning drive, o1-20 is adapted stepwise minimizing U4-53/U4-54. The parameter is automatically reset after 6 travels. To insure proper tuning, always drive the longest distance occurring in the lift installation.	0 - 1	0
S7-33	BrakDistOffset	Adds an offset to the current braking distance and I7 telegram reply for the braking distance. This forces a lift controller to perform distance prolongation earlier (safety margin). Note: This parameter is not used in CAN-Lift.	0.0 - 20.0%	0.0%
S7-34	RescPRMSetActive	Enables evacuation speed d1-25 to be used as limiting V4 DCP speed. 0: Disabled 1: Enabled Although V4 (d1-01) might be commanded by the controller, d1-25 is used as the limiting DCP speed. In that case, V4 is displayed in the FREF menu. Note: This parameter is not used in CAN-Lift.	0 - 1	0

■ Added Standard Parameter Scroll Items

Parameter	Operator Display	Description	Value Range	Default Value
b1-01	Ref Source 1	Speed Reference Selection 1 0: Operator Keypad 1: Terminals 2: Memobus/Modbus Communications 3: Option Card 6: DCP/CANopen-Lift	0 - 3, 6	H5-13 = 1: 0
				H5-13 ≠ 1: 6
b1-02	Run Source 1	Up / Down Command Selection 0: Operator Keypad 1: Control Circuit Terminal 2: Memobus/Modbus Communications 3: Option Card 6: DCP/CANopen-Lift	0 - 3, 6	H5-13 = 1: 1
				H5-13 ≠ 1: 6

■ Modified Standard Parameters

Only modified parameters are listed in this table. If parameter H5-13 = 3 or 4 or 5, the following changes apply:

Parameter	Operator Display	Description	Value Range	Default Value
A1-02	Control Method	Control Method Selection Selects the control method the drive uses to operate the motor. Note: If H5-13 = 4 or 5 (in Profile Position mode), the control method must be changed to 3 or 7.	If H5-13 ≠ 4: 0 to 7	0
			H5-13 = 4: 3 or 7	0
b6-01 to b6-04	Dwell Function	Dwell Function Parameters	H5-13 ≥ 4: [not available]	
b7-01 to b7-02	Droop Control	Droop Control Parameters	H5-13 ≥ 4: [not available]	
C1-01	Accel Time 1	Acceleration Time 1 Sets the ramp to accelerate from 0 to maximum speed	0.00 - 600.00 s	3.00 s
C1-02	Decel Time 1	Acceleration Time 1 Sets the ramp to from maximum speed to 0	0.00 - 600.00 s	3.00 s

6 DCP Interface

Parameter	Operator Display	Description	Value Range	Default Value
C1-03 to C1-08	Accel Time 2 ... 4 Decel Time 2 ... 4	Acceleration Time 2 to 4 Deceleration Time 2 to 4	H5-13 \geq 4: [not available]	
C1-11	Acc/Dec SW Freq	Accel/Decel Switching Speed Sets the speed to switch between accel/decel ramp settings Note: If H5-13 \geq 4: Parameter fixed to 0.0%	0.0 - 100.0%	0.0%
C2-03	Jerk@Decel Start	Jerk at Deceleration Start Sets the jerk used at the start of deceleration	If H5-13 < 4: 0.00 - 10.00 s	0.50 s
			If H5-13 \geq 4: 0.01 - 10.00 s	
C2-04	Jerk@Decel End	Jerk at Deceleration End Sets the jerk used at the end of deceleration	0.00 - 10.00 s	H5-13 < 4: 0.50 s
				H5-13 \geq 4: 2.00 s
C2-05	Jerk @ Leveling	Jerk at Leveling Sets the jerk used when the speed reference is lower than the leveling speed setting	H5-13 \geq 4: [not available]	
C2-06	SpdCtrl Dly Time	ASR Primary Delay Time Constant Sets the filter time constant for the time from the speed loop to the torque command output	H5-13 \geq 4: [not available]	
C3-01	Slip Comp Gain	Slip Compensation Gain	H5-13 \geq 4: [not available]	
C3-05	Output V Lim Sel	Output Voltage Limit Operation Selection	H5-13 \geq 4: [not available]	
d1-01 to d1-07, d1-23, d1-24, d1-26	<i>Refer to Added Standard Parameter Dependencies (Defaults) on page 60</i> Parameters d1-□□ are not used or modified for H5-13 = 5.			
d1-18	Spd Ref Sel Mode	Speed Reference Selection Mode	[not available]	
d2-01	Ref Upper Limit	Frequency Reference Upper Limit	[not available]	
o1-12	Length Unit Sel	Length Unit Selection 0: mm 1: inch Note: Parameter o1-12 does not change on initialization.	0, 1	0
o1-20	Traction Sheave Diameter	Sets the traction sheave diameter. Note: If H5-13 \geq 4 parameter o1-12 has one additional decimal place.	H5-13 < 4: o1-12 = 0: 100 - 2000 mm o1-12 = 1: 3.94 - 78.74 in	H5-13 < 4: o1-12 = 0: 400 mm o1-12 = 1: 15.75 in
			H5-13 \geq 4: o1-12 = 0: 100.0 - 1660.0 mm o1-12 = 1: 3.937 - 65.354 in	H5-13 \geq 4: o1-12 = 0: 400.0 mm o1-12 = 1: 15.748 in
o2-01	LO/RE Key	Determines if the digital operator LOCAL/REMOTE key is functional. 0: Disabled 1: Enabled	H5-13 =5: not available	
S1-01	ZeroSpeed@Stop	Zero Speed Level at Stop	H5-13 < 4: 0.000% to 9.999%	0.200%
			H5-13 \geq 4: 0.001% to 9.999%	
S1-05	DC Brk Time Stop	DC Braking Time at Stop Determines how long the drive should perform DC Injection at stop. In CLV and CLV/PM, S1-05 determines how long Position Lock should be performed. A setting of 0.00 disables S1-05. When H5-13 \geq 4 is selected, the minimum time is S1-07 + 0.1 s	0.10 - 10.00 s	0.60 s
S3-20	Dwell 2 Speed Reference	Sets the speed reference for the Dwell 2 function.	H5-13 \geq 4: [not available]	
S3-21	Dwell 2 End Speed	The Dwell 2 function will end when the drive reaches this speed.	H5-13 \geq 4: [not available]	
S4-02 to S4-04, S4-06 to S4-15	Rescue Operation	Rescue Operation Parameters	H5-13 \geq 4: [not available]	
S5-01 to S5-13		Short Floor Operation Selection	H5-13 \geq 4: [not available]	

■ Modified Standard Monitors

Only modified monitors are listed in this table.

Monitor	Operator Display	Description	Analog Output Scaling	Unit
U4-18	Reference Source	<p>Displays the source for the speed reference as XY-nn.</p> <p>X: indicates which reference is used 1 = Reference 1 (b1-01)</p> <p>Y-nn: indicates the reference source 0-01 = Digital operator 1-01 = Analog (terminal A1) 1-02 = Analog (terminal A2) 3-01 = MEMOBUS/Modbus communications 4-01 = Communication option card 5-00 = CANopen Lift 6-00 = DCP</p>	-	Hex
U4-21	Run Cmd Source	<p>Displays the source for the Up/Down command as XY-nn.</p> <p>X: Indicates which Up/Down command source is used: 1 = Reference 1 (b1-02)</p> <p>Y: Input power supply data 0 = Digital operator 1 = External terminals 3 = MEMOBUS/Modbus communications 4 = Communication option card 5 = CANopen Lift 6 = DCP</p> <p>nn: Up/Down command limit status data 00: No limit status. 01: Up/Down command was left on when stopped in the PRG mode 02: Up/Down command was left on when switching from LOCAL to REMOTE operation 03: Waiting for soft charge bypass contactor after power up (Uv or Uv1 flashes after 10 s) 04: Waiting for "Up/Down Command Prohibited" time period to end 05: Emergency Stop (multi-function input, operator) 07: During baseblock while coast to stop with timer 08: Speed reference is below minimal reference during baseblock 09: Waiting for Enter command</p>	-	-
U4-42 to U4-44		Direct Landing	If H5-13 ≥ 4 [not available]	

■ Added Standard Monitors

Monitor	Operator Display	Description	Analog Output Scaling (H4-□□ selection)	Unit
U4-50	Rem Distance	Remaining Distance Shows the remaining distance until the commanded distance is reached (value originating from lift controller, contains distance prolongations)	10 V: 65.535 m	o1-12 = 0: 0.001 m
			10 V: 2580 in	o1-12 = 1: 0.01 in
U4-51	Braking Distance	Braking Distance Shows the braking distance for a currently driven speed (matches the remaining distance at the time of deceleration)	10 V: 65.535 m	o1-12 = 0: 0.001 m
			10 V: 2580 in	o1-12 = 1: 0.1 in
U4-52	Int Dist Cmd	Internal Distance Command Shows the total commanded distance including prolongations (calculated from remaining distance)	10 V: 100.00 m	o1-12 = 0: 0.01 m
			10 V: 3937 in	o1-12 = 1: 0.1 in
U4-53	UpLinLimTime	Upper Linear Limit Time Applies an upper linear limit during C2-04 deceleration part. In case the positioning parameters are not set properly, this limit avoids jumps of the lift car at the beginning of C2-04 time	-	ms
U4-54	DownLinLimTime	Lower Linear Limit Time Applies a lower linear limit during C2-04 deceleration part. In case the positioning parameters are not set properly, this limit avoids jumps of the lift car at the beginning of C2-04 time	-	ms
U4-55	Shft Ctrl Input	Shaft Controller Input Shows the difference between remaining distance based on shaft PG and motor PG	-	o1-12 = 0: 0.001 mm o1-12 = 1: 0.01 in
U4-56	Shft Ctrl Output	Shaft Controller Output Shows the shaft controller output correction value per scan, added to the absolute position value based on motor PG	-	o1-12 = 0: 0.001 mm o1-12 = 1: 0.01 in
U4-57	Shft Ctrl O/PSum	Shaft Controller Output Sum Shows the accumulated control effort of the shaft controller (positive and negative values cancel out)	-	o1-12 = 0: 0.001 m o1-12 = 1: 0.001 in
U4-58	Absolute RemDist	Absolute Remaining Distance Shows the absolute initial distance when starting a travel, for controllers using Distance Shortening.	-	o1-12 = 0: 0.001 m o1-12 = 1: 0.01 in
U4-71	BrakingDist V0	Shows the braking distance occurring when decelerating from d1-26 speed. Note: This monitor is not available for CANopen-Lift.	-	o1-12 = 0: 0.001 m
U4-72	BrakingDist VN	Shows the braking distance occurring when decelerating from d1-23 speed. Note: This monitor is not available for CANopen-Lift.		
U4-73	BrakingDist V1	Shows the braking distance occurring when decelerating from d1-04 speed. Note: This monitor is not available for CANopen-Lift.		
U4-74	BrakingDist V2	Shows the braking distance occurring when decelerating from d1-03 speed. Note: This monitor is not available for CANopen-Lift.		
U4-75	BrakingDist V3	Shows the braking distance occurring when decelerating from d1-02 speed. Note: This monitor is not available for CANopen-Lift.		
U4-76	BrakingDist V4	Shows the braking distance occurring when decelerating from d1-01 speed. Note: This monitor is not available for CANopen-Lift.		
U4-77	BrakingDist V5	Shows the braking distance occurring when decelerating from d1-07 speed. Note: This monitor is not available for CANopen-Lift.		
U4-78	BrakingDist V6	Shows the braking distance occurring when decelerating from d1-06 speed. Note: This monitor is not available for CANopen-Lift.		
U4-79	BrakingDist V7	Shows the braking distance occurring when decelerating from d1-05 speed. Note: This monitor is not available for CANopen-Lift.		
				o1-12 = 1: 0.001 in

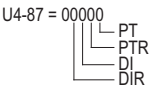
Monitor	Operator Display	Description	Analog Output Scaling (H4-□□ selection)	Unit
U4-82	Command Byte	First byte of DCP frame (Controller to Drive) B0: Drive Controller Enable B1: Travel Command B2: Stop Switch B3: Travel command transfer in data bytes B4: Travel Direction B5: Speed Change B6: Remaining Distance B7: Error in last reply message	-	-
U4-83	Status Byte	First byte of DCP frame (Drive to Controller) S0: Drive Controller Ready S1: Travel active S2: Alarm active S3: Fault active S4: Motor speed below 0.3 m/s S5: Distance accepted S6: Brake open S7: Error in last reply message	-	-
U4-84	Peak Brak Dist	Peak Braking Distance Shows the maximum braking distance occurring for profiles with linear acceleration part. U4-84 shows the maximum value taking all d1-xx speeds into account. If there is no speed high enough to produce a linear acceleration portion (C2-01 and C2-02 are fully driven), the monitor will show a 0 value. The value must be transferred/set in Strack SLC4-20 controller parameter DCPVzAbst.	-	01-12 = 0: 0.001 m
			-	01-12 = 1: 0.01 in
U4-85	I0 Cmd Rcv Ctr	I0 Command Reception Counter Counts the valid I0 commands received by the drive. The counter will roll after 65535 counts.	-	0 - 65535
U4-86	I1 Cmd Rcv Ctr	I1 Command Reception Counter Counts the valid I1 commands received by the drive. The counter will roll after 65535 counts.	-	0 - 65535
U4-87	I1 DIR DI PTR PT	I1 Command Request and Reply Shows Data Information Type Request (DIR) from controller, Data Information Type (DI) acknowledged by inverter, Protocol Type Request (PTR) from controller, and acknowledged Protocol Type (PT) 	-	-
U4-88	I6 Cmd Rcv Ctr	I6 Command Reception Counter Counts the valid I6 commands received by the drive. The counter will roll after 65535 counts.	-	0 - 65535
U4-89	I7 Cmd Rcv Ctr	I7 Command Reception Counter Counts the valid I7 commands received by the drive. The counter will roll after 65535 counts.	-	0 - 65535
U4-90	I7 Rx Data V4	I7 Reception Data when V4 Commanded Shows the distance command transferred in an I7 message (controller to inverter) with V4 speed selection.	-	01-12 = 0: 0.001 m
			-	01-12 = 1: 0.01 in
U4-91	I7 Rx Data V3	I7 Reception Data when V3 Commanded Shows the distance command transferred in an I7 message (controller to inverter) with V3 speed selection.	-	01-12 = 0: 0.001 m
			-	01-12 = 1: 0.01 in
U4-92	I7 Tx Data Sg	I7 Transmit Data Sg Shows the total distance to be traveled according to the transferred distance command.	-	01-12 = 0: 0.001 m
			-	01-12 = 1: 0.01 in

6 DCP Interface

Monitor	Operator Display	Description	Analog Output Scaling (H4-□□ selection)	Unit
U4-93	I7 Tx Data Sv	I7 Transmit Data Sv Shows the deceleration distance according to the transferred distance command.	-	o1-12 = 0: 0.001 m
			-	o1-12 = 1: 0.01 in
U4-94	I9 Cmd Rev Ctr	I9 Command Reception Counter Counts the valid I9 commands received by the drive. The counter will roll after 65535 counts.	-	0 - 65535

■ Added Standard Parameter Dependencies

The baud rate for DCP operation is specified as 38400 baud. When DCP operation is selected by H5-13, the baud rate of the Memobus port, accessible via terminals R+, R-, S+, S-, is automatically set to 38400 baud. The values of the following parameters are changed automatically according to the settings of H5-13.

Dependent Parameter	H5-13 = □				
	0 (DCP Com Channel)	1 (Memobus/Modbus)	3 (DCP3)	4 (DCP4)	5 (CANopen-Lift)
b1-01 (sequence)	6 (DCP)	0 (Operator Keypad)	6 (DCP)	6 (DCP)	6 (DCP)
b1-02 (reference)	6 (DCP)	1 (Control Circuit Terminal)	6 (DCP)	6 (DCP)	6 (DCP)
F6-35	0 (Node ID)	0 (Node ID)	0 (Node ID)	0 (Node ID)	2 (Node ID)
F6-36	6 (500 kBaud)	6 (500 kBaud)	6 (500 kBaud)	6 (500 kBaud)	5 (250 kBaud)
H3-02	0 (Frequency Bias)	0 (Frequency Bias)	1F (not used)	1F (not used)	1F (not used)
H5-02	5 (38400 Baud)	3 (9600 Baud)	5 (38400 Baud)	5 (38400 Baud)	3 (9600 Baud)
H5-11	1 (Enter Cmd not necessary)	0 (Enter Command necessary)	1 (Enter Cmd not necessary)	1 (Enter Cmd not necessary)	1 (Enter Cmd not necessary)
S4-01	3 (Advanced)	0 (Disabled)	3 (Advanced)	3 (Advanced)	0 (Disabled)

Note: 1. Parameter values are set to default when H5-13 is changed.

2. Power must be cycled after switching H5-13 ≠ 1 or when switching back to setting 1 in order to make the new H5-02 setting effective.

■ Added Standard Parameter Dependencies (Defaults)

H5-13 = □	0	1	3	4	5	3, 4	0, 1, 5
Parameter	Default Value					Parameter Texts	
C1-01	3.00 s	1.50 s	3.00 s			-	-
C1-02	3.00 s	1.50 s	3.00 s			-	-
d1-01	0.00%		100.00%	0.00%		V4 Speed	Reference 1
d1-02	0.00%		64.00%	0.00%		V3 Speed	Reference 2
d1-03	0.00%		40.00%	0.00%		V2 Speed	Reference 3
d1-04	0.00%					V1 Speed	Reference 4
d1-05	0.00%					V7 Speed	Reference 5
d1-06	0.00%					V6 Speed	Reference 6
d1-07	0.00%					V5 Speed	Reference 7
d1-23	0.00%		1.00%	0.00%		VN Speed	Releveling Speed
d1-24	50.00%		25.00%	50.00%		V1 Speed	Inspect Oper Spd
d1-26	8.00%		4.00%	8.00%		V0 Speed	Leveling Speed

■ Changes of Standard Digital Input Multi-Functions (DIMF)

DIMF Availability by H5-13 Setting

H1-□□ Setting (Hex)	Function Name	H5-13 = 0, 1	H5-13 = 3 (DCP3)	H5-13 = 4 or 5 (DCP4 or CANopen-Lift)
3 to 5	Multi-Step Speed Reference 1~3	Available	Not available	Not available
6	JOG Reference Selection		Available	
7	Accel/Decel time selection		Not available	
16	Motor 2 Selection		Available	
1A	Accel/Decel Time Selection 2		Not available	
50	Nominal Speed		Not available	
51	Intermediate Speed			
52	Releveling Speed			
53	Leveling Speed			
54	Inspection Operation			
57	High Speed Limit (Up)			
58	High Speed Limit (Down)		Available	
5C	Floor Sensor			

When H5-13 \geq 3, values and defaults of the parameters H1-03 to H1-07 are set to 0xF (not used).

■ Changes of Standard Digital Output Multi-Functions (DOMF)

DOMF Availability by H5-13 Setting

H2-□□ Setting (Hex)	Function Name	H5-13 = 0, 1	H5-13 = 3, 4, 5
1C (11C)	Motor 2 Selection	Available	Not available

DOMF Availability by S4-01 Setting

H2-□□ Setting (Hex)	Function Name	S4-01 < 3	S4-01 = 3
55 (155)	Light Load Direction Detection Status	Available	Not available

Added DOMF

H2-□□ Setting (Hex.)	Operator Display	Description	Available in Control Method
70 (170)	In Position	The lift car has reached the commanded target position within S7-01 bandwidth for a minimum continuous time of S7-02	CLV, PMCLV

■ Changes of Standard Analog Input Multi-Functions (AIMF)

AIMF Availability by H5-13 Setting

H3-□□ Setting (Hex)	Function Name	H5-13 = 0, 1	H5-13 = 3, 4, 5
0	Speed Reference Bias	Available	Not available
2	Auxiliary Speed Reference 1		
3	Auxiliary Speed Reference 2		

When H5-13 \geq 3, value and default of parameter H3-02 are set to 0x1F (not used).

When H5-13 \geq 3, default of parameter H3-10 is set to 0x1F (not used).

■ Added Faults and Modified Errors

Added DCP Faults

Fault	Fault Code (Hex.)	Fault Display	Description	Cause	Countermeasure
DCE1	61	DCP CRC Error	Drive Control Position Cyclic Redundancy Check Error A CRC8 check failed 10 times consecutively during RUN	EMC, bad serial link	Shield serial link. Check serial RS-485 connection (Termination Resistance switched by S2)
DCE2	62	DCP Init Error	Drive Control Position Initialization Error A Run command was given although no valid initialization command ('1') was received	EMC, bad serial link	Check if lift controller sends valid initialization command
DOE1	63	DCP OPE	Drive Control Position Operation Error A Run command was given although the inverter was in Alarm state	Alarm	Remove alarm condition. Lift controller must not give Run during Alarm state

Modified OPE Errors

Error	Description	Cause	Countermeasure
oPE18	DCP3, DCP4, CANopen Lift: If b1-01 is set to 6 "DCP" and b1-02 is set \neq 6 or vice versa, oPE18 is shown.	b1-01 = 6 AND b1-02 \neq 6, b1-02 \neq 6 AND b1-02 = 6	Set b1-01 = 6 AND b1-02 = 6

Modifications of FREF Menu Texts

Menu Text	Display		Displayed when	Description
	Active Speed (Command by Lift Controller)	Message Text		
ME-01	V0	FreqRef(DCP-V0)	b1-01 = 6	DCP sequence is activated (also used for CANopen Lift) VN: Releveling speed VI: Inspection speed VF: Fast Start speed (0Hz)
	V1	FreqRef(DCP-V1)		
	V2	FreqRef(DCP-V2)		
	V3	FreqRef(DCP-V3)		
	V4	FreqRef(DCP-V4)		
	V5	FreqRef(DCP-V5)		
	V6	FreqRef(DCP-V6)		
	V7	FreqRef(DCP-V7)		
	VN	FreqRef(DCP-VN)		
	VI	FreqRef(DCP-VI)		
	VF	FreqRef(DCP-VF)		
	undefined	FreqRef(DCP)		
ME-01	FreqRef(CANLift)		H5-13 = 5	CANopen Lift uses DCP sequence internally. Differentiation is done by H5-13

◆ Positioning Operation

Velocity Profile Input Control

Taking ramping times (C1-01, C1-02) and jerk settings (C2-01 to C2-04) of the inverter into account, a suitable velocity profile is determined which matches the remaining distance and which does not exceed the limiting DCP speed. The limiting DCP speed is transferred by the lift controller to the inverter before the travel starts.

Besides the velocity profile input control, a shaft controller aligns the traveled distance based on motor PG with the lift car position based on shaft PG. In order to reduce the control effort for the shaft controller, o1-20, o1-21, and o1-22 settings must be accurate. It is especially recommended to set o1-20 as exact as possible (rope-center to rope-center value).

As mentioned before, an optimal setting of o1-20 greatly improves positioning performance. o1-20 is usually tuned with switched-off shaft controller (S7-13 = 0). A coarse tuning at the beginning of commissioning is usually done by comparing the lift speeds shown by lift and drive controller. In this case, the lift car is typically moved in inspection speed. When the lift controller shows higher speeds than the drive, o1-20 setting needs to be lowered; when it shows slower speeds, o1-20 is to be increased.

If the speeds match sufficiently (some percent mismatch are tolerable at this time), Sheave Diameter Auto-Tuning can be performed.

Sheave Diameter Auto-Tuning

After each successful position mode travel, the Sheave Diameter Auto-Tuning function adapts o1-20 settings automatically using tuning monitors U4-53 and U4-54. After 8 travels, the tuning stops and S7-32 is reset automatically. If o1-20 values still change by some 0.1 mm, the tuning can be repeated by setting S7-32 to 1 again. Note that one 8-travel tuning cycle can correct o1-20 by roughly up to 10.0 mm only.

Shaft Controller Tuning

The shaft controller compares the remaining distance to travel with the remaining distance based on motor PG. In some cases, especially with high pulse count PGs, it is necessary to reduce the shaft controller output gain (S7-13).

◆ Adjustment Procedures

■ General Tuning Requirements for Profile Position Mode

1. Select inverter control mode (CLV or PM CLV; requires pulse counter (PG) feedback)
2. Perform Auto-tuning
3. Set H5-13 to 4 (profile positioning is performed with setting 4)
4. Tune complete ASR, i.e. C5-01/C5-03/C5-13, C5-02/C5-04/C5-14.
It is very important to have a low ASR response time in order to obtain good leveling results.
This is mainly achieved when C5-02/C5-04/C5-14 have low values (< 80ms). Higher C5-01/C5-03/C5-13 values (ASR gains) are also recommended.
5. Set o1-20, o1-21, o1-22 values, especially o1-20 as precise as possible (set the sheave diameter from rope-center to rope-center if possible).
6. Set a high C2-04 value at the beginning (C2-04 ≥ 2.00 sec).
7. Compare speeds of lift controller and drive controller using inspection speed.
These values should be similar with a tolerance of about 3%. If deviations are bigger, adjust o1-20.
Recommendation: Switch drive controller units to m/s (o1-03 = 4).
8. Perform a DCP4 positioning travel one floor up or down.
9. Minimize U4-53 and U4-54 by adjusting o1-20.
10. Repeat steps 8 and 9 until either U4-53 or U4-54 reach values below 300 ms.
11. Perform Sheave diameter auto-tuning by setting S7-32 to 1.
12. Perform DCP4 positioning travels with the maximum possible drive distance of the lift 3 times up, 3 times down.
The drive controller adjusts o1-20 automatically.
After these 6 travels, S7-32 is set to 0 and no further adaption of o1-20 occurs.
13. If necessary, adjust shaft controller gains.
Input gain: S7-09; Output gain: S7-13

Note: Proper positioning operation is not performed when C2-04 is 0 or short.

Sheave Diameter Auto-Tuning

After each successful position mode travel, the Sheave Diameter Auto-Tuning function adapts o1-20 settings automatically using tuning monitors U4-53 and U4-54. After 8 travels, the tuning stops and S7-32 is reset automatically. If o1-20 values still change by some 0.1 mm, the tuning can be repeated by setting S7-32 to 1 again. Note that one 8-travel tuning cycle can correct o1-20 by roughly up to 10.0 mm only.

Shaft Controller Tuning

The shaft controller compares the remaining distance to travel with the remaining distance based on motor PG. In some cases, especially with high pulse count PGs, it is necessary to reduce the shaft controller output gain (S7-13).

A change of the P-Output gain can improve the positioning quality. Using the I-part can also help in some cases, however, avoid small settings (< 0.5 s). A value of 0 switches-off the I-part.

Optional: Zero-Servo Tuning

The last bit of the distance (1 to 3 mm) during a positioning operation can be performed by the Zero-Servo controller. Its properties are governed by S3-□□ parameter group. With higher gain settings (S3-03, Stop Position Lock Gain), the remaining leveling error is driven by a quick movement which can be undesired.

The remaining distance after deceleration by ASR controller (end of C2-04 time) is fed into the Zero-Servo function at that threshold. The maximum speed during that correction can be limited by S3-05. With slower speeds, the correction takes longer but possibly yields a higher riding comfort and is less discernible. A compromise has to be found. To avoid any roll-back at stop, set S3-05 to 0.

Optional: Shaft Position Trimming

The DCP specification does not allow the lift controller to transfer negative remaining distance values to the inverter. This can lead to overruns by about +0...4 mm due to control impairment. To overcome this restriction, parameter S7-30 can be used to trim an earlier termination of the overall profile by some millimeters. For example, a lift tending to overrun by +0...4 mm can be trimmed to reach the level with -2...+2 mm deviation. In this example, set S7-30 to -2 mm (systematic error correction amount).

7 CANopen-Lift

Yaskawa CANopen-Lift implementation refers to CiA-417: Profile for Lift Control Systems. Supported operation modes are Profile Velocity mode and Profile Position mode. The Yaskawa CANopen-Lift fieldbus option card SI-L3 is required.

To enable CANopen-Lift functionality, set parameter H5-13 = 5, b1-01 and b1-02 = 6, and perform a power-cycle. Some parameters will be changed automatically. [Refer to Added Standard Parameter Dependencies \(Defaults\) on page 60.](#)

Parameter groups are commonly used in CANopen-Lift and in DCP mode. Therefore the following descriptions refer to DCP parameter and monitor tables.

◆ Characteristics of CANopen-Lift Interface

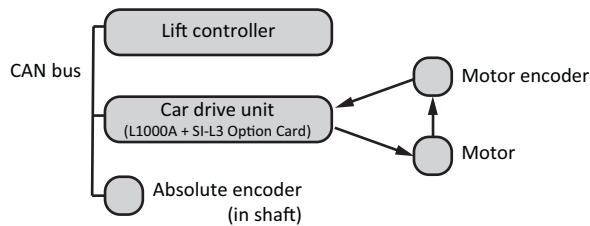

Figure 27 Connection using CANopen-Lift

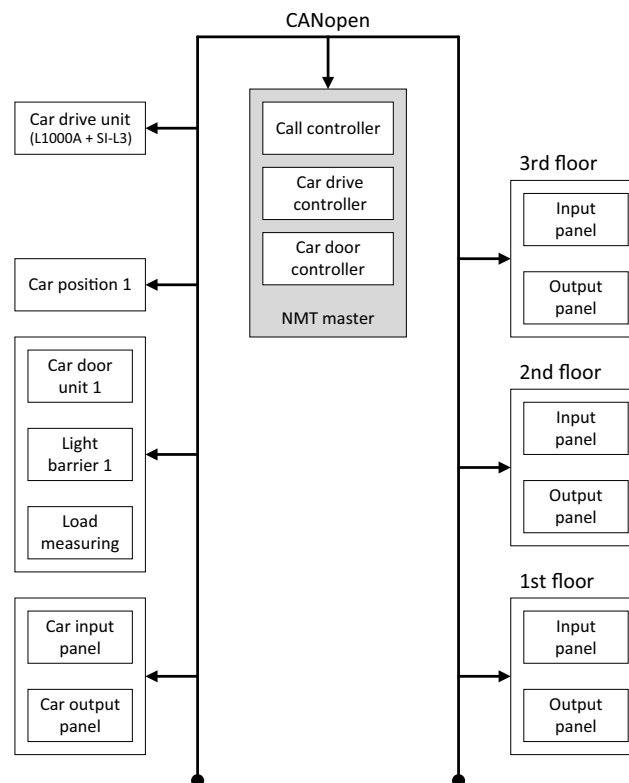

Figure 28 Example for a single network architecture for a single-shaft lift control system

The L1000A together with the SI-L3 option card is a car drive unit and moves the car upwards and downwards. It receives the motion commands from the car drive controller. It is based on the CANopen profile for drives and motion control (see /IEC61800-7-201/ and /IEC61800-7-301/). There are some additional objects required for lift applications that are not specified in /IEC61800-7-201/. If there is no absolute encoder supported, the target velocity ([Refer to 6430 \(Hex\): Target Velocity on page 74](#)) is provided to the car drive unit using the Profile Velocity Mode. If there is an absolute encoder available, the target position ([Refer to 6420 \(Hex\): Target Position on page 72](#)) is provided to the car drive unit using the Profile Position Mode. The operation mode is selected by the modes of operation ([Refer to 6403 \(Hex\): Modes of Operation on page 72](#)).

In case of velocity controlled drives the Profile Velocity Mode is used. The objects for the velocity profile are stored in the drive unit and may be configured by the lift controller. Due to safety reasons, configuration is not possible in Operation Enable state of the car drive unit. The car drive unit state machine is controlled by the control word (*Refer to 6400 (Hex): Control Word on page 69*). Drive-specific functions such as motor relays are operated locally in the drive unit or in the lift controller. Target velocity unequal 0 determines motion in case of a Operation Enable command. The sign of target velocity indicates direction; positive values indicate upward motion of the car. Sense of rotation depends on mounting position. The drive unit indicates reaching the target velocity in the 10th bit of the status word (*Refer to 6401 (Hex): Status Word on page 70*).

In case of position controlled drives the Profile Position Mode should be used. To configure the ramps and S curves the same parameters as for velocity mode are used. After setting a new position, the drive unit calculates the curve and starts motion. During motion the drive controller may change target position. If the control effort allows stopping at the new target position, this is indicated in the 12th bit of the status word. If the drive cannot stop at the new target position, the drive unit moves to the previous target position. Reaching a target position is indicated in the 10th bit of the status word.

◆ Added and Modified Parameters, Monitors, Dependencies, Functions, and Faults

■ Added Standard Parameters

Parameter	Operator Display	Content	Value Range	Default Value
F6-95	Min level diff	Minimum level difference. Sets the upper limit for the traveling distance commanded per step even if the controller issues bigger distances in one step.	o1-12 = 0: 0 ... 10000 mm	o1-12 = 0: 500 mm
			o1-12 = 1: 0.00 ... 393.70 in	o1-12 = 1: 19.69 in

■ Added Standard Parameter Scroll Items

Refer to Added Standard Parameter Scroll Items on page 55.

■ Modified Standard Parameters

Refer to Modified Standard Parameters on page 55.

■ Modified Standard Monitors

Refer to Modified Standard Monitors on page 57.

■ Added Standard Monitors

Refer to Added Standard Monitors on page 58.

■ Added Standard Parameter Dependencies (Defaults)

Refer to Added Standard Parameter Dependencies (Defaults) on page 60.

■ Changes of Standard Input and Output Multi-Functions

Refer to Changes of Standard Digital Input Multi-Functions (DIMF) on page 61.

Refer to Changes of Standard Digital Output Multi-Functions (DOMF) on page 61.

Refer to Changes of Standard Analog Input Multi-Functions (AIMF) on page 61.

■ Added Faults and Modified Errors

Added CANopen-Lift Faults

Fault	Fault Code (Hex.)	Fault Display	Content	Cause	Counter-measure
CLoE	68	CLoE	CANopen Lift Operation Error	<ul style="list-style-type: none"> Speed limit (obj. 6423h) is set to 0 during position mode travel. A position mode travel is commanded while the momentary position is invalid (0) or the commanded distance is 0 for 20.0 s (fixed) after entering "operation enabled" state. A position mode travel is completed and the lift controller did not disable the "enable operation" command. Position mode: the momentary position is not > 0 for 20.0 s (fixed) during the travel. 	

Modified OPE Errors

Refer to Modified OPE Errors on page 62.

Modifications of FREF Menu Texts

Refer to Modifications of FREF Menu Texts on page 62.

◆ Object Dictionary

Explanation of Data Types:

Data Type	Explanation	Data Type	Explanation
UNS8	Unsigned 8 bit value	SINT8	Signed 8 bit value
UNS16	Unsigned 16 bit value	SINT16	Signed 16 bit value
UNS32	Unsigned 32 bit value	SINT32	Signed 32 bit value
String	Character String		

■ Supported General Communication Objects

1000 (Hex): Device Type

Index (Hex)	Sub	Content	Acc.	Range	Initial Value (Hex)
1000	0	Device Type	RO	UNS32	0900 01A1h

This object describes the type of device and its functionality.

Bit 0 - 15	Device Profile Number (01A1 (Hex))
Bit 16 - 23	Reserved
Bit 24 - 31	Virtual Device Code (09 (Hex))

1001 (Hex): Error Register

Index (Hex)	Sub	Content	Acc.	Range	Initial Value (Hex)
1001	0	Error Register	RO	UNS8	0

This register shows the fault status of the device. If any errors occurs in the device, bit 0 (generic error) is set to one.

Bit	Definition
0	Generic error
1	Current
2	Voltage
3	Temperature
4	Communication error (overflow, error state)
5	Device profile specific
6	reserved (always 0)
7	manufacturer-specific

1003 (Hex): Pre-defined Error Field

Index (Hex)	Sub	Content	Acc.	Range	Initial Value (Hex)
1003	0	Number of errors	RW	(0, 1)	0
1003	1	Standard error field	RO	UNS32	0

This register provides a history of errors that occurred in the drive and have been signaled via the Emergency object. Subindex 0 contains the number of errors. Sub index 01 (Hex) contains a rolling list of error codes where sub index 1 always contains the last occurring error.

The number of valid logged errors in sub index is 01 (Hex). Writing a 0 to subindex 0 resets the error field.

7 CANopen-Lift

1008 (Hex): Manufacturer Device Name

Index (Hex)	Sub	Content	Acc.	Range	Initial Value (Hex)
1008	0	Manufacturer Device Name	RO	String	SI-L3

This object displays the name of the connected option card.

1009 (Hex): Manufacturer Hardware Version

Index (Hex)	Sub	Content	Acc.	Range	Initial Value (Hex)
1009	0	Manufacturer Hardware Version	RO	String	1.10

- Note:** 1: Major hardware version
10: Minor hardware revision assigned during production

This object contains the option card hardware version.

100A (Hex): Manufacturer Software Version

Index (Hex)	Sub	Content	Acc.	Range	Initial Value (Hex)
100A	0	Manufacturer Software Version	RO	String	VST923200

This object contains the manufacturer software version.

Example:

Software version number: VST923200

- VST9: Option card for L1000A
- 2: European product
- 32: Bus type "CANopen Lift"
- 0: Major revision
- 0: Minor revision

1016 (Hex): Consumer Heartbeat Times

Index (Hex)	Sub	Content	Acc.	Range	Initial Value (Hex)
1016	0	Number of Supported Virtual Devices	RO	01 - 7F	2
1016	1	Consumer Heartbeat Times 1	RW	UNS32	0001 0BB8
1016	2	Consumer Heartbeat Times 2	RW	UNS32	0004 0BB8

Consumes the heartbeat from all CANopen devices in multiples of 1 ms.

Bit 0 - 15	Heartbeat Time
Bit 16 - 23	Node-ID
Bit 24 - 31	Reserved (0)

1017 (Hex): Producer Heartbeat Times

Index (Hex)	Sub	Content	Acc.	Range	Initial Value (Hex)
1017	0	Producer Heartbeat Times	RW	UNS16	03E8

Produces the heartbeat. The heartbeat time is given in multiples of 1 ms. Default value is 1 s (1000 ms = 03E8 (Hex)).

1018 (Hex): Identity Objects

Index (Hex)	Sub	Content	Acc.	Range	Initial Value (Hex)
1018	0	Number of Entries	RO	0 - 4	1
1018	1	Vendor ID	RO	UNS32	0100 00E7

This object contains general information about the drive.

■ Supported General Application Objects

6008 (Hex): Specification Version

Index (Hex)	Sub	Content	Acc.	Range	Initial Value (Hex)
6008	0	Specification Version	RO	UNS16	2222

This object contains the profile specification version, binary coded decimal code is used.

600A (Hex): Virtual Terminal Interface

Index (Hex)	Sub	Content	Acc.	Range	Initial Value (Hex)
600A	0	Number of Entries	RO	2	2
600A	1	Virtual Terminal Input	RW	UNS32	0
600A	2	Virtual Terminal Output	RO	UNS32	0

This object consists of four characters to transmit the sub-objects in MPDOs. The object can store characters, e.g. from a keypad, and can provide characters, e.g. for a display.

■ Supported Car Drive Objects

6383 (Hex): Position Value

Index (Hex)	Sub	Content	Acc.	Range	Initial Value (Hex)
6383	0	Number of Entries	RO	0 - 4	1
6383	1	Position Unit 1	RW	UNS32	FFFF FFFF

This objects contains the position values measured by the car position units (shaft encoder increments).

6400 (Hex): Control Word

Index (Hex)	Sub	Content	Acc.	Range	Initial Value (Hex)
6400	0	Control Word	RW	UNS16	0

This object indicates the received command controlling the PDS FSA.

Bit	Definition
0	Switch on
1	Enable voltage
2	Quick stop
3	Enable operation
4	New set-point (only in profile Position Mode)
5	Change set immediately (only in profile Position Mode)
6	Abs / rel (only in profile Position Mode)
7	Fault reset
8	Halt
9	Change on set-point (only in profile Position Mode)

7 CANopen-Lift

Bit	Definition
10	Reserved (0)
11	
12	
13	
14	Emergency recall operation mode
15	Car top inspection mode

Command coding:

Command	Bits of the control word					Transitions
	Bit 7	Bit 3	Bit 2	Bit 1	Bit 0	
Shutdown	0	x	1	1	0	2, 6, 8
Switch on	0	0	1	1	1	3
Switch on + enable operation	0	1	1	1	1	3+4 Refer to Note.
Disable voltage	0	x	x	0	x	7, 9, 10, 12
Quick stop	0	x	0	1	x	7, 10, 11
Disable operation	0	0	1	1	1	5
Enable operation	0	x	1	1	1	4, 16
Fault reset	0 -> 1	x	x	x	x	15

Note: Automatic transition to Enable operation state after executing SWITCHED ON state functionality.

Refer to Use of Control Word and Status Word on page 76.

6401 (Hex): Status Word

Index (Hex)	Sub	Content	Acc.	Range	Initial Value (Hex)
6401	0	Status Word	RO	UNS16	0

This object provides the status of the PDS FSA.

Bit	Definition
0	Ready to switch on
1	Switched on
2	Operation enabled
3	Fault
4	Voltage enabled
5	Quick stop
6	Switch on disabled
7	Warning
8	Reserved
9	Remote
10	Target reached
11	Internal limit active
12	Set-point acknowledge (profile Position Mode) Speed (profile Velocity Mode)
13	Following error (profile Position Mode) Max. slippage error (profile Velocity Mode)
14	Not used
15	

State coding:

Status word	LDS FSA state	Status word	LDS FSA state
xxxx xxxx x0xx 0000 _b	Not ready to switch on	xxxx xxxx x01x 0111 _b	Operation enabled
xxxx xxxx x1xx 0000 _b	Switch on disabled	xxxx xxxx x00x 0111 _b	Quick stop active
xxxx xxxx x01x 0001 _b	Ready to switch on	xxxx xxxx x0xx 1111 _b	Fault reaction active
xxxx xxxx x01x 0011 _b	Switched on	xxxx xxxx x0xx 1000 _b	Fault

If bit 4 (voltage enabled) of the status word is 1, this indicates that high voltage is applied.

If bit 5 (quick stop) of the status word is 0, this indicates that the inverter drive is reacting on a quick stop request.

If bit 7 (warning) of the status word is 1, this indicate the presence of a warning condition. Warning is not an error or fault. The status is not being changed.

If bit 9 (remote) of the status word is 1, this indicates that the control word is processed. If bit 9 is 0 (local), this indicates that the control word is not processed.

If bit 10 (target reached) of the status word is 1, this indicates that the set-point has been reached. This means: In profile Velocity Mode the set speed reference is reached; In profile Position Mode the position set point is reached.

If bit 11 (internal limit active) of the status word is 1, this indicates that an internal limit is active (example: position range limit).

Bit 12 and 13 of the status word are operation mode specific.

If a travel is ended by transition from control command "enable operation" to control command "disable voltage", the drive does not stop with a normal stopping ramp but with a coast to stop.

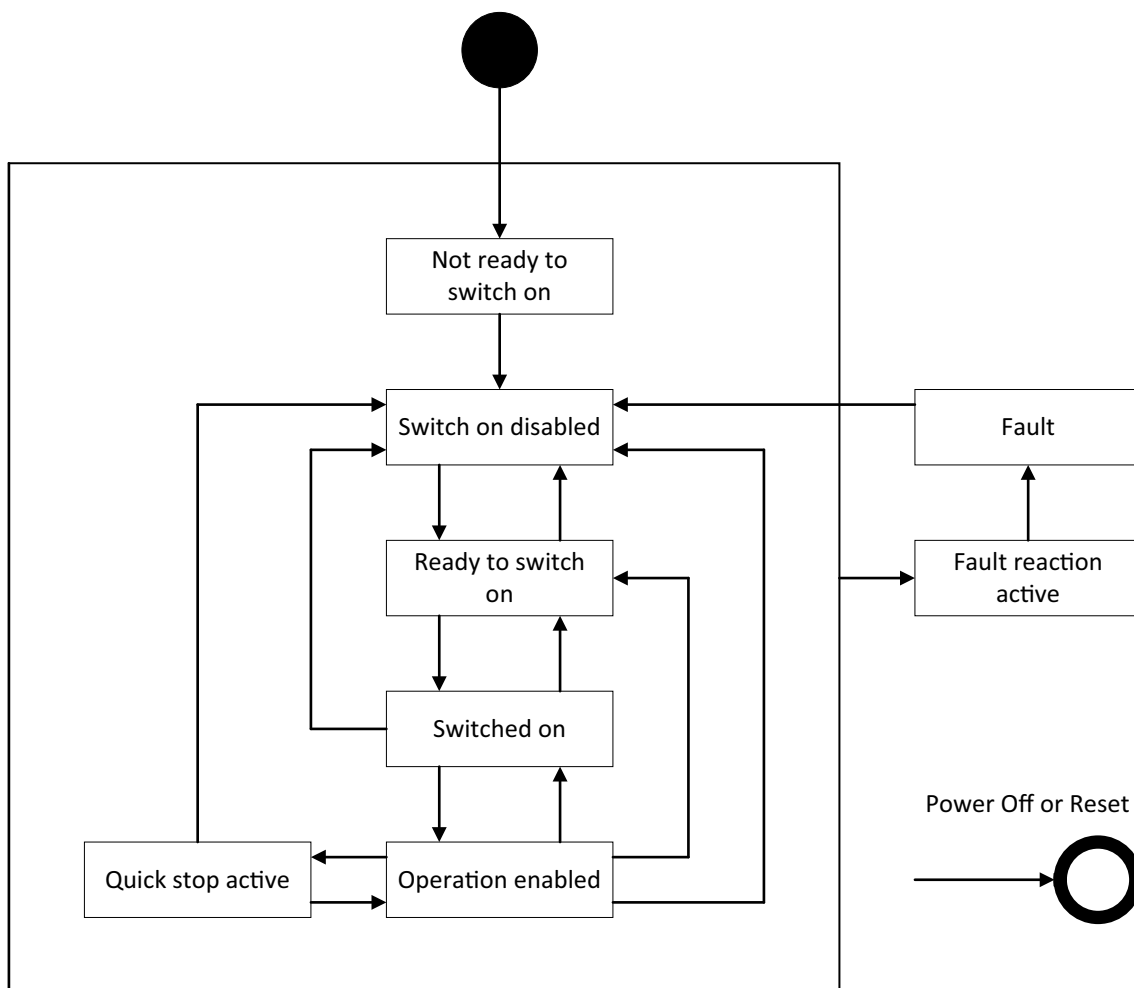

Figure 29 Finite state automation as implemented in SI-L3 option card

7 CANopen-Lift

6403 (Hex): Modes of Operation

Index (Hex)	Sub	Content	Acc.	Range	Initial Value (Hex)
6403	0	Modes of Operation	RW	01, 03	01

This object shows the value of the requested operation mode. The actual operation mode of the LDS is reflected in the object modes of operation display.

If	then
Object 6403 (Hex) = 01 (Hex)	Profile Position Mode
Object 6403 (Hex) = 03 (Hex)	Profile Velocity Mode

If the controller requests profile Position Mode while this is not possible, 6404 (Hex) will remain in profile Velocity Mode.

6404 (Hex): Modes of Operation Display

Index (Hex)	Sub	Content	Acc.	Range	Initial Value (Hex)
6404	0	Modes of Operation Display	RO	01, 03	01

This object provides the actual operation mode.

If	then
Object 6404 (Hex) = 01 (Hex)	Profile Position Mode
Object 6404 (Hex) = 03 (Hex)	Profile Velocity Mode

6406 (Hex): Control Effort

Index (Hex)	Sub	Content	Acc.	Range	Initial Value (Hex)
6406	0	Control Effort	RO	SINT32	0

This object contains the position where to start braking, as absolute value.

641F (Hex): Position Conversion

Index (Hex)	Sub	Content	Acc.	Range	Initial Value (Hex)
641F	0	Number of Entries	RO	2	2
641F	1	Number of Position Units	RW	UNS32	0
641F	2	Total Length in Millimeter	RW	UNS32	0

This object contains the conversion coefficients to convert the target position from the drive controller and the position value from the position device into millimeters (mm).

Note: To enable correct operation, this object must be configured by the drive controller.

6420 (Hex): Target Position

Index (Hex)	Sub	Content	Acc.	Range	Initial Value (Hex)
6420	0	Target Position	RW	SINT32	0

This object indicates the commanded position that the drive should move to in profile position mode. The value of this object must be set in terms of shaft encoder increments.

6421 (Hex): Position Range Limit

Index (Hex)	Sub	Content	Acc.	Range	Initial Value (Hex)
6421	0	Number of Entries	RO	UNS8	2
6421	1	Min Position Range Limit	RW	SINT32	0
6421	2	Max Position Range Limit	RW	SINT32	0

This object indicates the configured maximum and minimum position range limits. This object limits the numerical range of the input value. A position command which exceeds these limits is ignored. The "setpoint acknowledge" bit in the status word is not set. The values are given in terms of shaft encoder increments.

6423 (Hex): Profile Velocity

Index (Hex)	Sub	Content	Acc.	Range	Initial Value (Hex)
6423	0	Profile Velocity	RW	UNS32	0

This object sets an upper limit for the speed which is used in Profile Position Mode. The maximum speed in a Profile Position Mode travel may fall below the set value but may not exceed it. The value is given in multiples of 1 mm/s.

Note: The speed is limited to the value defined with parameter e1-04.

6430 (Hex): Target Velocity

Index (Hex)	Sub	Content	Acc.	Range	Initial Value (Hex)
6430	0	Target Velocity	RW	SINT32	0

This object indicates the configured target velocity and is used as input for the trajectory generator, and is used in Profile Velocity mode. The value is given in multiples of 1 mm/s.

Note: The speed is limited to the value defined with parameter e1-04.

6433 (Hex): Velocity Actual Value

Index (Hex)	Sub	Content	Acc.	Range	Initial Value (Hex)
6433	0	Velocity Actual Value	RO	SINT32	0

In Closed Loop control modes, this object provides the actual velocity value derived either from the velocity sensor or the position sensor. In Open Loop Vector (A1-02 = 2) or V/f (A1-02 = 0) modes, it is based on drive internal calculations. The value is given in multiples of 1 mm/s.

67FE (Hex): Byte Dummy

Index (Hex)	Sub	Content	Acc.	Range	Initial Value (Hex)
67FE	0	Byte Dummy	RO	UNS8	FF (Hex)

This object is used to fill one byte into a TPDO.

■ Receive PDOs

PDO Number	Receive PDO Parameter		Receive PDO Mappings	
	COB-ID (Hex)	Index (Hex)	Mapped Object (Hex)	Index (Hex)
259	182	1502	Sub-index 01: 6400 Sub-index 02: 6403 Sub-index 03: 0005 Sub-index 04: 6430	1702
261	180	1504	Sub-index 01: 6420 Sub-index 02: 6423	1704
263	18C	1506	Sub-index 01: 6383 sub1	1706

■ Transmit PDOs

PDO Number	Transmit PDO Parameter		Transmit PDO Mappings	
	COB-ID (Hex)	Index (Hex)	Mapped Object (Hex)	Index (Hex)
260	183	1903	Sub-index 01: 6401 Sub-index 02: 6404 Sub-index 03: 67FE Sub-index 04: 6433	1B03
262	181	1905	Sub-index 01: 6406	1B05

8 Ripple Compensation

Only available for PM CLV control method.

This function is intended for use when compensating $n \cdot f$ torque ripple on the motor shaft.

◆ Special Functions

Function	Description
Calculation of car inertia	The total car inertia (J) is calculated as follows: $[\text{System Inertia}] = ([\text{S8-08}] + [\text{S8-09}] + [\text{S8-10}] + [\text{S8-11}] + [\text{S8-12}]/2) * ([\text{o1-20}] / 4000)^2$ $J = [\text{S8-04}] + [\text{S8-06}] + [\text{S8-07}] + [\text{System Inertia}]$

◆ Function Description

Set the Kt value (S8-02) from motor data sheet or motor name plate.

Unit of Kt is Nominal Torque [Nm] / Nominal Current [A].

◆ Example

Elevator					
Parameter		Symbol	Value	Unit	Value from:
S8-08	Weight Cage	m_{Car}	1050	kg	Lift builder
S8-09	Weight Counter Weight	m_{Cwt}	1550	kg	Lift builder
S8-10	Weight Rope	m_{Rope}	70	kg	Lift builder
S8-11	Weight Pulley	m_{Pulley}	20	kg	Lift builder
S8-12	Maximum Load Weight	m_{Load}	0	kg	Lift builder

Motor: MSYP160					
Parameter		Symbol	Value	Unit	Value from:
S8-04	Motor Inertia	J_{Mot}	1.110	kgm ²	Motor manufacturer
S8-06	Pulley Inertia	J_{Pulley}	0.375	kgm ²	Lift builder
S8-07	Sheave Inertia	J_{Ts}	0.500	kgm ²	Motor manufacturer
	Roping Ratio		2:1	-	Motor manufacturer
	Rated Speed		1	m/s	Motor manufacturer
o1-20	Sheave Diameter		Ø 240	mm	Motor manufacturer

$$J = (1050 + 1550 + 70 + 20 + 0/2) \text{ kg} * ((240 / 4000) \text{ mm})^2 + 1.110 \text{ kgm}^2 + 0.375 \text{ kgm}^2 + 0.500 \text{ kgm}^2$$

$$J = 11.669 \text{ kgm}^2$$

8 Ripple Compensation

◆ Added Parameters for Ripple Compensation

Only available for PM CLV control method.

Parameter	MEMOBUS Address (Hex.)	Operator Display [Parameter Name]	Description	Range [Default]
S8-01	620	Ripple Compens. [Activate Ripple Compensation]	0: Disable 1: Enable	0, 1 [0]
S8-02	621	Kt value	Set the Kt value (Torque parameter) in Nm/A Unit of Kt is Nominal Torque [Nm] / Nominal Current [A].	0.00 - 200.00 [1.00]
S8-03	622	Tripple gain	Set the T_{ripple} gain	0.00 - 20.00 [0.30]
S8-04	623	Set mtr inertia [Jm (motor inertia)]	Set the motor inertia in kgm ²	0.000 - 60.000 [0.000]
S8-06	625	Set pull inertia [Jm (motor inertia)]	Set the pulley inertia in kgm ²	0.000 - 60.000 [0.000]
S8-07	626	Set shv inertia [JST (sheave inertia)]	Set the sheave inertia in kgm ²	0.000 - 60.000 [0.000]
S8-08	627	Weight Cage	Set the weight of the cage in kg	0 - 60,000 [0]
S8-09	628	Weight Cweight [Weight counter weight]	Set the weight of the counter weight in kg	0 - 60,000 [0]
S8-10	629	Weight Rope	Set the weight of the rope in kg	0 - 60,000 [0]
S8-11	62A	Weight Pulley	Set the weight of the pulley in kg	0 - 60,000 [0]
S8-12	62B	Max Load Weight [Maximum Load Weight]	Set the maximum load weight in kg	0 - 60,000 [0]

◆ Added Monitors for Ripple Compensation

Only available for PM CLV control method.

Monitor	MEMOBUS Address (Hex.)	Operator Display [Monitor Name]	Description	Analog Output Scaling
U4-60	862	RippleMon [%/Tn]	Estimated ripple [100%/Tn] in 0.1%	10 V: 100% Nominal Torque*
U4-61	863	Ripple Mon [N]	Estimated ripple [0.1 Nm] in 0.1 Nm	-

*Nominal torque is based on E1-06, E5-02, and E5-04

9 PM Play

When using the Yaskawa motors for Lifts, MSYP series, the function "PM Play" makes commissioning of lift installation easier. Just set parameter E5-01 using the motor code provided on the motor name plate. The Lift Inverter Drive will automatically adjust other parameters.

CE		Made in Europe		LANCOR 2000, S.Coop. Bizkaia (Spain)	
COD. 43060000227		1250_2:1_240/10x6.5ø			
Art-Nr:201250255		MCode 0009		Ser. No.: 21729098	
Motortype: MSYP-160.60-20poles Connections:					
Pn	12.3	Kw	Duty-C/h	S5-180	
U	315	V	Nm	255	Rpm
Fn	42.44	Hz	Mn	460	Nm
In	27.1	A	Ma	690	Nm
la	41	A	Encl.	IP-21	
Iso-class	F		Weight	307	Kg
Cooling	IC06		Produced	08-2017	

Parameters and constants modified by setting the parameter E5-01 are not displayed in the list "Modified Parameters & Constants".

10 Replacement Instructions for Smart Controller Drives

◆ Scope

The following describes how to replace the drive in Schindler Smart controllers with a YASKAWA L1000A inverter. This solution has been developed to replace drives used in Smart MRL 001 / 002 controllers.

◆ Requirements

The L1000A can almost directly replace existing drives. The only additional component needed is an external relay to control the brake.

YASKAWA recommends a relay from the 46.52 series made by Finder. When other relays are used it should be selected so that the excitation current of the coil does not exceed the specifications of the output M2 on the L1000A drive. Generally the relay should be selected so that the excitation current is as low as possible.



Figure 30 Finder relay

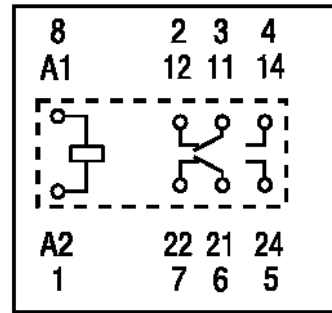

Figure 31 Circuit of the Relay

Table 1 DC Coil Data

Nominal Voltage	Coil Code	Operating Range		Resistance	Rated Coil Consumption
		Umin [V]	Umax [V]		
U _N [V]				R [Ohm]	I at U _N [mA]
24	9.024	17.5	26.4	1,200	20

◆ Wiring of the YASKAWA L1000 Inverter Drive

The following figure shows the wiring between the controller (connector XFCL) and the drive terminals.

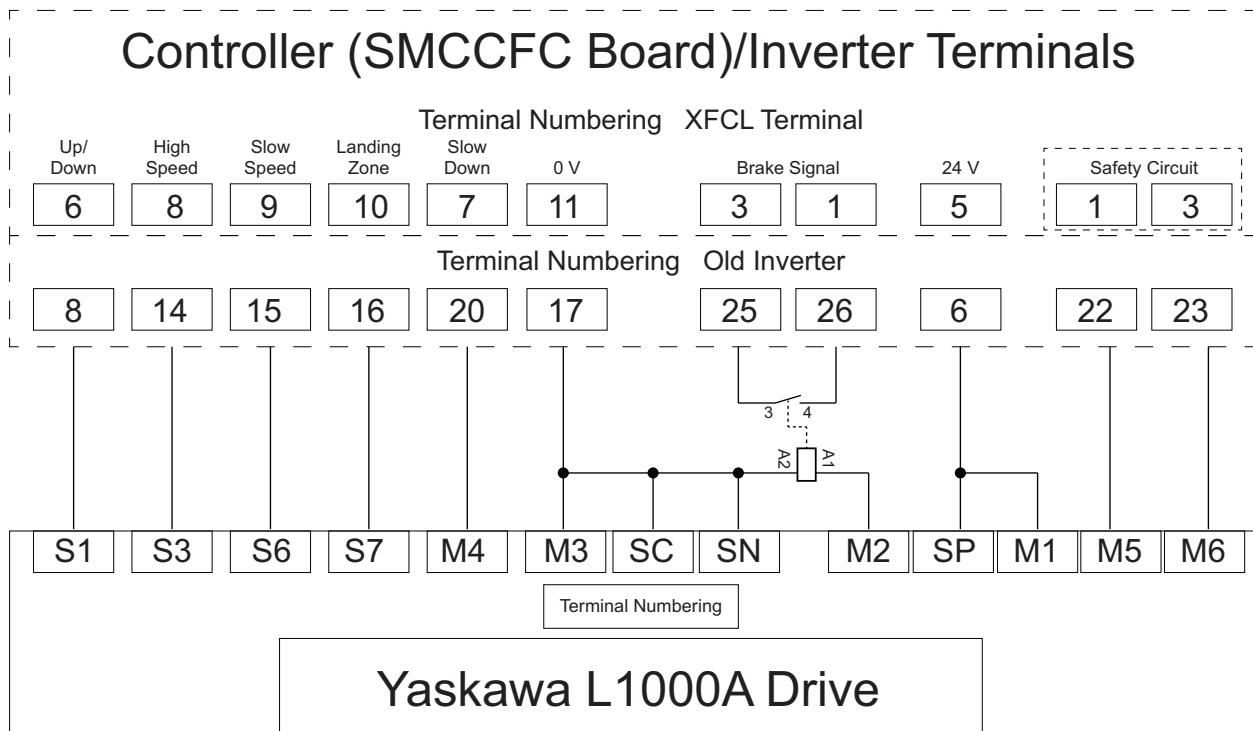

Figure 32 Wiring between Controller and Drive Terminals

The following table summarizes the terminal connections in the old and new configurations.

Table 2 Terminal Connections

Controller SMCCFC Terminal	Vacon Drive Terminal	YASKAWA L1000A Terminal	Brake Relay	Function
-		M2	A1	Connection for Brake Relay
1	26	-	4	
3	25	-	3	
5	6	SP, M1	-	-
6	8	S1	-	Direction / Run
7	20	M4	-	-
8	14	S3	-	Nominal /Fast speed
9	15	S6	-	Inspection / Leveling
10	16	S7	-	Landing Zone
11	17	SC, SN, M3 A2 (Relay Coil)	-	Connection for Brake Relay
1	22	M5	-	Safety Circuit
3	23	M6	-	

◆ Start Up

After wiring, power on the drive and follow these steps:

1. Enter the programming mode of the L1000A.
2. Set parameter d1-18 to 4 (Smart Replacement).
This operation sets I/O's to operate with the Smart controller.
The next step is to enter motor data to the drive.
3. Set drive parameters.
Table 3 and 4 show a typical example of a 6.7 kW machine and the appropriate setting values for drive parameters.

Table 3 Motor Nameplate (Example)

U = Δ / Y 400 ΔV	f = 33 Hz	cos φ 0,85
P = 6,7 kW	I = 13,5 A	RPM = 950 min-1
		Starting Torque = TA/TN 2,75
S5 240, F/h 50 % ED		Inertia = I mot 0,32 kgm ²
IEC34 - 1	Protection degree = IP21	Insulation = KI F

Table 4 Recommended Parameters (Example)

Parameter Name	Setting Value
E1-04	Maximum Output Frequency 33 Hz*
E1-05	Maximum Voltage 400 V*
E1-06	Base Frequency 33 Hz*
E1-09	Minimum Output Frequency 0.1 Hz*
E2-01	Motor Rated Current 13.5 A*
E2-02	Motor Rated Slip 1.30 Hz*
E2-03	Motor No Load Current 6 A*
E2-11	Motor Rated Power 6.7 kW*
S1-07	Brake Close Delay Time 0.3 sec
S1-10	Run Command Delay Time 0.4 sec
S6-02	Starting Current Error (SE2) Detection Delay Time 500 ms
S6-03	SE2 Detect Current Level 35 %
S6-04	Output Current Error (SE3) Detection Delay Time 500 ms

* According to the (Example) Motor Nameplate

4. Enter the Auto-Tuning menu.
5. Set parameter T1-01 to 2 for “Stationary Auto-Tuning for Line-to-Line Resistance”.
6. Enter the nameplate data in the Auto-Tuning menu.
 - T2-02 = Motor Power (kW)
 - T2-04 = Motor Current (Amps)

7. After entering the data listed on the motor nameplate, press the UP-button until the following message is displayed:
 “0.00 Hz/0.00 A Tuning Ready? Press RUN key”.

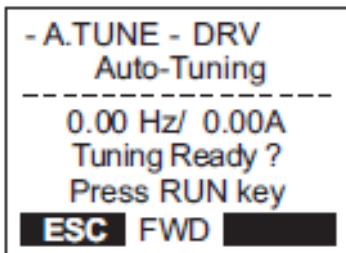

Figure 33 Tuning ready?

8. Make sure the motor contactors SR-D and SH-1 or SR-U and SH-1 are closed before starting the Auto-Tuning procedure.

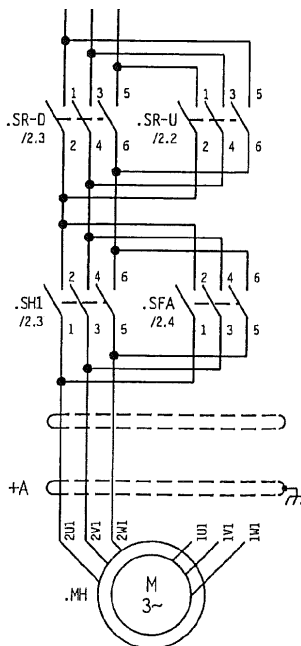

Figure 34 Motor Contactors

9. Press the RUN-button to start the Auto-Tuning procedure.
 The message “Tune Proceeding” is displayed.

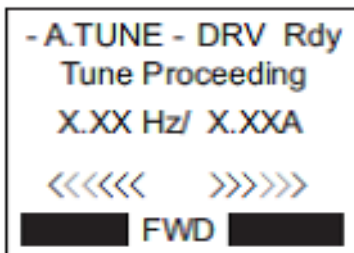

Figure 35 Auto-Tuning Proceeding

The drive begins by injecting current into the motor for about 1 minute.
 The tuning process is completed, as soon as the drive displays the message “End Tuning Successful”.

10. Open the motor contactors.

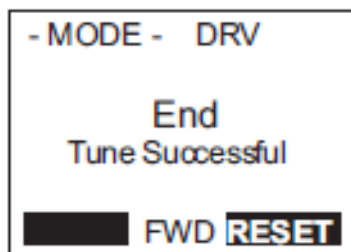

Figure 36 Tune Successful

Now the system is ready to run in normal operation.

11. Fine tune acceleration and jerk using the following parameters.

Parameter Value	Description
C1-XX	Acceleration
C2-XX	Jerk

The system will start with the learning run. This sequence is done by the controller without intervention from the user.

11 Appendix



TYPE EXAMINATION CERTIFICATE FOR LIFTCOMPONENTS

Issued by Liftinstituut B.V.

Certificate no.	: NL13-400-1002-184-01	Revision no.:	3
Description of the product	: Brake monitoring as part of the protection against unintended car movement and/or ascending car overspeed means		
Trademark, type	: Yaskawa, CIMR-LCxAXxxxxxx – 910x and CIMR-LCxFXxxxxxx – 91xx		
Name and address of the Manufacturer	: Yaskawa Electric UK LTD 1 Hunt Hill Orchardton Woods Cumbernauld G68 9LF United Kingdom	Yaskawa Electric Corporation	2-13-1-Nishimiyaichi Yukuhashi-City Fukuoka 824-8511 Japan
Name and address of the certificate holder	: Yaskawa Europe GmbH Hauptstr. 185 D-65760 Eschborn Germany		
Certificate issued on the following requirements	: Lifts Directive 2014/33/EU		
Certificate based on the following standard	: EN 81-20:2014 clause 5.6.6.2 and 5.6.7.3		
Test laboratory	: None		
Date and number of the laboratory report	: None		
Date of type examination	: June 13, 2017		
Additional document with this certificate	: Report belonging to the type examination certificate no.: NL13-400-1002-184-01 rev.3		
Additional remarks	: None		
Conclusion	: The lift component meets the requirements referred to in this certificate taking into account any additional remarks mentioned above.		

Amsterdam

Date : 27-06-2017
Valid until : 30-03-2020

A handwritten signature in blue ink, appearing to read 'J.L. van Vliet'.

ing. J.L. van Vliet
Managing Director

A handwritten signature in blue ink, likely representing the certification decision.

Certification decision by

Report type-examination

Report belonging to type-examination certificate no.	: NL13-400-1002-184-01
Date of issue of original certificate	: June 25, 2012
Concerns	: Lift component
No. and date of revision	: 3; June 27, 2017
Requirements	: Lifts Directive 2014/33/EU Standard: EN 81-20:2014 clause 5.6.6.2 and 5.6.7.3
Project no.	: P170177

1. General specifications

Name and address manufacturer	: Yaskawa Electric UK LTD 1 Hunt Hill Orchardton Woods Cumbernauld G68 9LF United Kingdom and Yaskawa Electric Corporation 2-13-1-Nishimiyaichi Yukuhashi-City Fukuoka 824-8511 Japan
Description of lift component	: Brake monitoring as part of the protection against unintended car movement and/or ascending car overspeed means
Type	: Yaskawa, CIMR-LCxAXxxxxxx – 910x and CIMR-LCxFXxxxxxx – 91xx
Laboratory	: -
Address of examined lift component	: -
Data of examination	: June 2013, June 2017
Examination performed by	: A. v/d Burg, P.J. Schaareman

2. Description lift component

The brake monitoring described in this report shall be used in combination with a suitable detection system and a suitable brake to build an unintended car movement protection and/or ascending car overspeed means for lifts.

The monitoring function that is integrated in the frequency inverter becomes effective after parameter S6-17 is set to 1.

Two inputs can be programmed to monitor the correct opening and closing of brakes, it can be done with both normally closed or both normally open contacts.

The activated system will stop the lift when at least one programmed brake monitoring inputs detects one of the following situations:

- When the brake monitoring signal changes status for a time period longer than set with parameter "S6-06" during a trip (Default 500 ms, range 0-60 sec.) (This function is optional).
- When the brake monitoring signal does not change status within a time period set with parameter "S6-05" after the brake is ordered to open during a trip (Default 500 ms, range 0-10 sec.).
- When the brake monitoring signal does not change status within a time period set with parameter "S6-05" after the brake is ordered to close after a trip (Default 500 ms, range 0-10 sec.).

After detection of brake malfunction, the lift remains out of service, also after switching off- and on the supply power or using the "reset" button.

Resetting of the system is only possible by setting the parameter "S6-18 = 1".

Technical data of the inputs:

Voltage	: +24 VDC
Switching level low/high	: typ. 11,85 VDC
Input current at 24 V	: typ. 12,6 mA

3. Examinations and tests

The examination covered a check whether compliance with the Lift Directive 2014/33/EU is met, based on the harmonized product standard EN 81-20:2014. Issues not covered by or not complying these Standards are directly related to the above mentioned essential requirements based on the risk assessment, where applicable with the aid of harmonized A-and B-standards.

The examination included:

- Examination of the technical file (See annex 2):
- Examination of the representative model in order to establish conformity with the technical file.

4. Results

After the final examination the product and the technical file were found in accordance with the requirements.

5. Conditions

On the type-examination certificate the following conditions apply:

- Before taking the lift into service and after each change in the software of the Yaskawa, CIMR-LCxAXxxxxxx – 910x or CIMR-LCxFXxxxxxx – 91xx the proper functioning of the brake monitoring must be checked. The checking shall be done by disconnecting and short circuiting the brake monitoring switches one by one. Each time after a command is given, the manipulation shall be detected by the system and a reset shall be necessary to bring the lift back into operation.

6. Conclusions

Based upon the results of the type-examination Liftinstituut B.V. issues a type-examination certificate.

The type-examination certificate is only valid for products which are in conformity with the same specifications as the type certified product. The type-examination certificate is issued based on the requirements that are valid at the date of issue. In case of changes of the product specifications, changes in the requirements or changes in the state of the art the certificate holder shall request Liftinstituut B.V. to reconsider the validity of the type-examination certificate.

Prepared by:

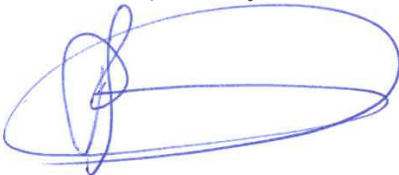

P.J. Schaareman
Product Specialist Certification
Liftinstituut B.V.

Certification decision by:



Annexes

Annex 1 : Impression Yaskawa frequency inverter

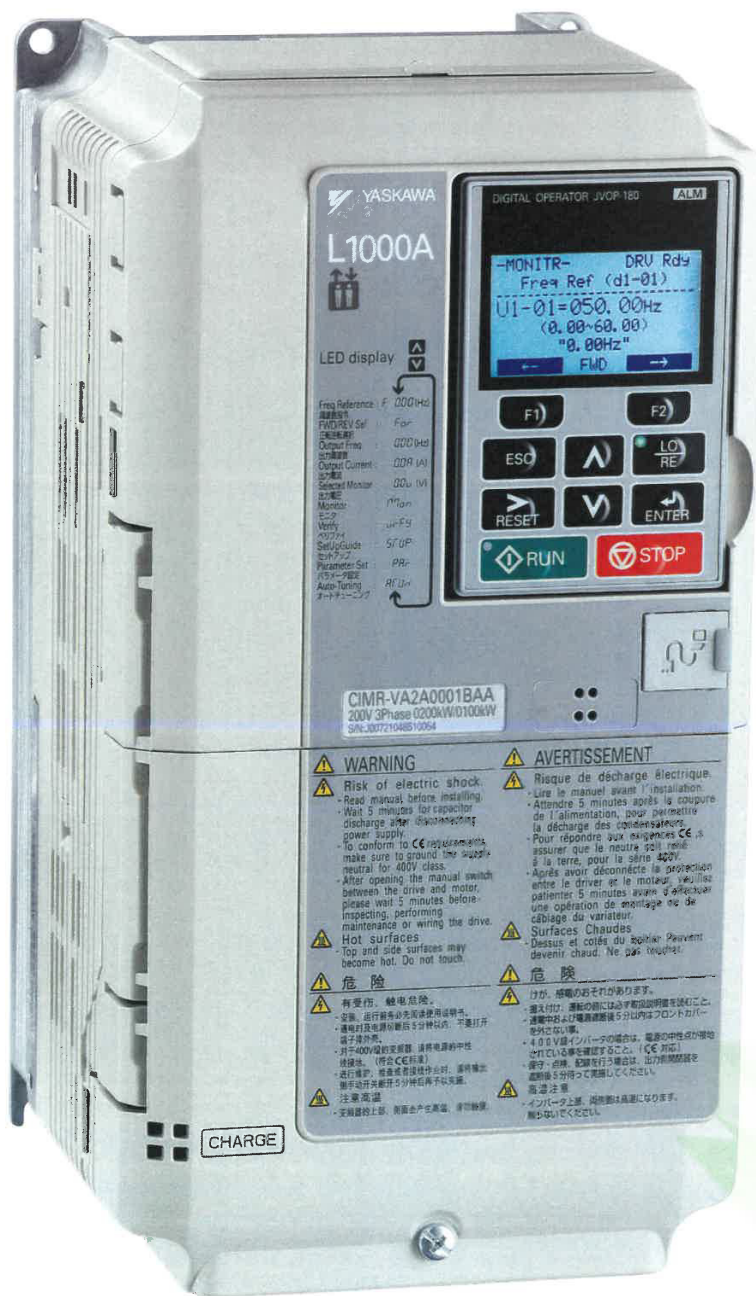

Annex 2: Documents of the Technical File which were subject of the examination

Title	Date
Software Functional Specification.docx	13-03-2013
Software Functional Specification.docx rev.1	09-04-2013
Brake Status Monitor Operation Manual	13-06-2013

Annex 3: Reviewed deviations from the standards

EN xx-x par.	Requirement	Accepted design
x.x.x	-	-

Annex 4: Revision overview

Rev.:	Date	Summary of revision
-	25-06-2013	Original
1	10-09-2013	Product name changed
2	30-03-2015	Addition of CIMR-LCxFxxxxxxx – 91xx
3	27-06-2017	Addition of brake monitoring application for ascending car overspeed means and update to new Lifts Directive 2014/33/EU

Revision History

Date of Publication	Revision	Section	Revised Content
March 2018	F	2, Appendix	Revision: Updated Certificate and Norm
August 2017	E	All	Revision: Document Structure; Document Title Addition: DI-A3 Option Multi-functional Support; 6F Ripple Compensation; Advanced Light Load Search; Output Phase Loss Protection
February 2016	D	4	Addition: Replacement instructions Revision: Document structure
April 2015	C	1, Appendix	Revision: Standards; Scope Revision: Certificate
May 2014	B	All	Revision: Document structure Addition: DCP3 interface
October 2013	A	-	First edition