

Typennummer / Identification

BLOCK	BLOCK	B 0908065	Filter Typ	Type of filter	3~ EMI Filter
Kunde	Customer	FB-40072A	Baureihe	Model Family	HLD 110

Technische Daten / Technical Data

Phasenzahl	No. of phase		3
Bemessungsspannung	Rated voltage	[V]	480
Bemessungsfrequenz	Rated frequency	[Hz]	50-60
Bemessungsstrom I _n	Rated current I _n	[A]	72
Ableitstrom [1]	Nominal leakage current	[mA]	207
Ableitstrom [2]	Nominal leakage current	[mA]	22
Verlustleistung	Power loss	[W]	40
Strom Derating	Current derating	> 50°	- 3% I_n / K
Prüfspannung	High voltage test	[V-]	2150 Line-line
	High voltage test	[V-]	2700 Line-case

Prinzipschaltbild / Typical circuit diagram:

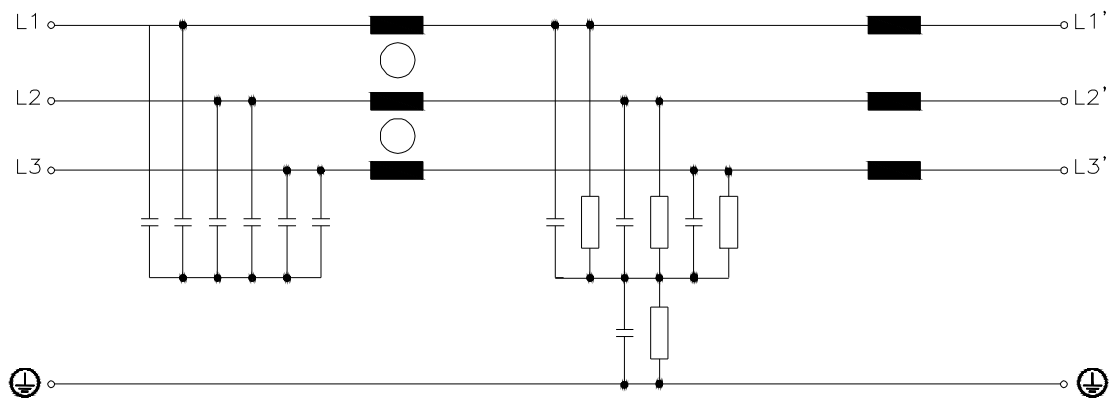

Betriebsbedingungen / Operating conditions

Schutzart	Protection index		IP 20
Umgebungstemperatur	Ambient temperature	[°C]	+50°C
Klimaklasse	Climatic category		25/085/21 [in accordance with EN 60068-1]
Kühlungsart	Type of cooling		AN (natürliche Luftkonvektion/neutral air convection)
Luftgeschwindigkeit	Air speed	[m/s]	-
Betriebsart	Operating conditions		DB (Dauerbetrieb / continuous operation)

Ausführung / Standards

Typ / Type:	Datum / Date	Zeichen / Signs
EN 60939-2	2006	

Bemerkung / Notes

[1] = Berechnet bei max. Eingangsspannung und dem Ausfall von 2 Phasen (typ. @50Hz)	[1] = Calculated for max. line voltage tolerance, by loss of two phases (typ @ 50Hz)
[2] = Bemessen auf die max. zulässige Eingangsspannungsschwankung nach IEC 38 ± 10%.	[2] = @ max. allowed voltage fluctuation in accordance with IEC 38 ± 10%
Die angegebenen technischen Daten sind typisch. Material- und fertigungsbedingt können Abweichungen auftreten.	Technical specifications are typical. They can vary due to material and production tolerances.

Date:	08.10.09	Schutzvermerk gemäß DIN 34 beachten	Datei	B 0908065
Name:	Heuermann		Änderung	a
Date:	08.10.09	Observe protection clause to DIN 34	Document	Filter01
Checked:	Kornau		Abteilung	EWN

Mechanische Daten / Mechanical Data

Bemessungsstrom	Rated current	[A]	72
Abmessung A	Dimensions A	[mm]	270
Abmessung F	Dimensions F	[mm]	310
Abmessung B	Dimensions B	[mm]	85
Abmessung C	Dimensions C	[mm]	135
Befestigungsmaße D	Mounting D	[mm]	60
Befestigungsmaße E	Mounting E	[mm]	255
Befestigungsschrauben	Mounting screws		M6
Gewicht (netto)	Weight	[kg]	4,7

Anschlüsse / Terminals

Eingang	Input	[mm ²]	35
Ausgang	Output	[mm ²]	35
PE Anschluß	PE Terminal	Bolzen / bolt	M8

Aufbauskizze / Construction drawing

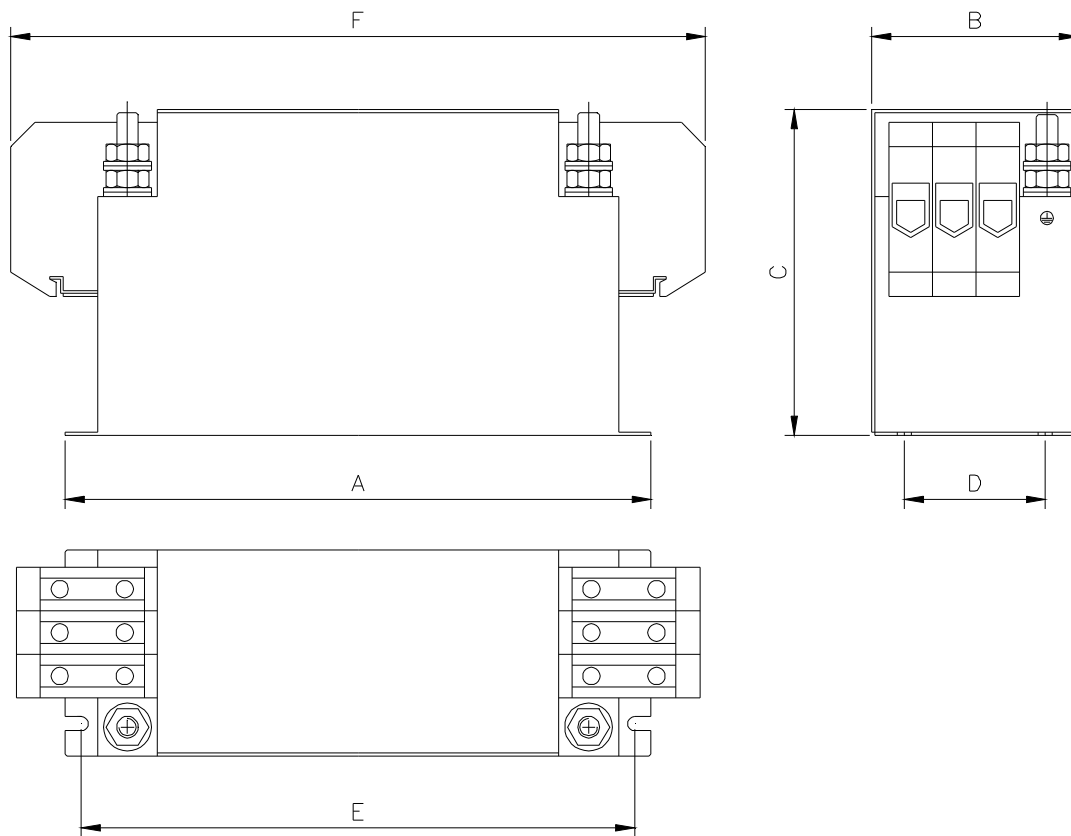

Bemerkung / Notes

Einzelheiten der Darstellung in der Aufbauskizze sind unverbindlich.
Allgemeintoleranzen DIN 7168-c
Änderungen vorbehalten.

Technical specifications are typical.
General tolerance to DIN 7168-c.
Subject to change.

Date:	08.10.09	Schutzvermerk gemäß DIN 34 beachten	Datei	B 0908065
Name:	Heuermann		Änderung	a
Date:	08.10.09	Observe protection clause to DIN 34	Document	Filter01
Checked:	Kornau		Abteilung	EWN